

ROCK KRAWLER S U S P E N S I O N

INSTALLATION MANUAL

FOR

ROCK KRAWLER SUSPENSION, INC.

JT SILVERBACK SYSTEMS

2021 1st EDITION

06/30/2021



ROCK KRAWLER S U S P E N S I O N

Dear customer: Thank you for purchasing the best system on the market for your Jeep Vehicle. We are sure you will be happy with this system after your installation is complete. Please take your time during the installation and be sure to do it correctly. Completely read the directions before starting your installation so you know what to expect. Remember, your personal safety depends on it. Should you have any questions during this installation feel free to give our tech line a call (518-270-9822) and we will be happy to help you.

Welcome to TEAM RK

Share your before & after pictures, install photos & wheeling images.

facebook



@RKSuspension

Instagram



@rock_krawler

Note: BE SURE TO CHECK ALL FASTENERS FOR PROPER TORQUE BEFORE TEST DRIVE. RECHECK AFTER 500 MILES AND BE SURE TO CHECK PERIODICALLY.

WARNING

- Properly block and secure vehicle prior to installation.
- Always wear safety glasses when using power tools.
- Rock Krawler Suspension recommends the use of Loctite on all hardware, unless noted otherwise.
- The use of limiting straps is recommended to avoid possible damage from over extending the suspension of your vehicle.
- Read and understand all instructions, warnings and safety precautions in these instructions and your owner's manual before attempting to install these components.
- Proper installation of Rock Krawler Suspension products requires knowledge of recommended procedures for disassembly/assembly of OE vehicles and components. Access to OE shop manuals and special tools are required. Attempting to install this kit without knowledge of these procedures may affect the safety of your vehicle and or the performance of these components. Rock Krawler Suspension, Inc. strongly recommends that this system be installed by a certified mechanic with off road experience.
- Rock Krawler Suspension does not recommend combined use of suspension lifts, body lifts or other lift devices. Combined use of lifts may result in unsafe and unexpected handling characteristics. Also, many states now have laws restricting Vehicle lift, bumper heights and other alterations. Consult local laws to determine if your proposed alterations (including installation of this system) comply with your state laws.
- Rock Krawler Suspension does not condone or authorize the use of any other suspension components with its products. Should Rock Krawler Systems or components be installed in junction with other products or not per the provided instructions Rock Krawler Suspension warranty is void and is not to be held accountable for any resulting actions.

ROCK KRAWLER

S U S P E N S I O N

Driving and Handling Tips

- For Highway driving it is best to have the front sway bar connected. This will give you the on highway ride and handling characteristics you expect. **If you choose otherwise, you do so at your own risk.**
- The ride quality and handling that Rock Krawler is known for is based on using OEM sway bars front and rear with approved shocks. Using any components other than directed can result in adverse handling characteristics and poor ride quality.
- For Off-Road use it is best to have the front sway bar disconnected and the rear sway bar connected. This will allow your suspension to do its intended function. Our suspension will give your vehicle unmatched articulation which will provide traction and feedback to keep your vehicle moving in almost all conditions. Let the suspension do the work! Even if you are a Rubicon Owner for most situations we recommend manually disconnecting the front sway bar.

IMPORTANCE OF JAM NUTS

This is a note about jam nuts and the consumer's responsibility. The installer is the person or persons initially responsible for the proper setup of the suspension system and/or components and the initial tightening of the jam nuts. The jam nuts not only hold the orientation of the joint it is on but it is the single component that puts the necessary pre-load on the joints threads. The consumer or vehicle owner is the person or persons responsible for maintaining the jam nuts tightness. Failure to do so will result in the rapid deterioration of the threads in the control arm and will impose a "cause for concern" for the occupants of the vehicle. Failure to comply with the warnings heeded in the directions regarding the amount of threads showing past the jam nut will also result in the same "cause for concern" for the occupants of the vehicle. All of the above items are the responsibility of the vehicle owner and or installer. If a threaded section of a component is bad it will show itself defective immediately. Threads that fail over time are due to improper maintenance of jam nuts and can be proven very easily. Thread sections and jam nuts not properly maintained or setup, are not covered under warranty. This is the end user and installer's responsibility.

ORIENTATION OF JOINTS

Orient the Krawler Joint for maximum amount of movement with the head of joint perpendicular to bolt / head of the joint vertical in the mounting bracket. This same rule for orientation needs to be followed for all heim joints. The photo below shows the right way (LEFT SIDE) and the wrong way (RIGHT SIDE) to orient a joint.

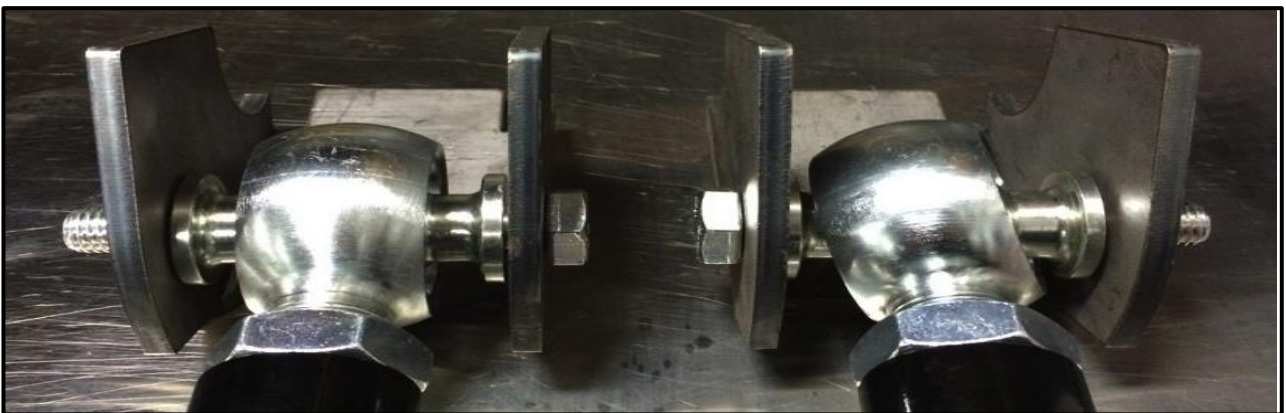

^RIGHT WAY^

^WRONG WAY^



MAINTAINING JOINTS AND SUSPENSION COMPONENTS

Krawler Joints/Pro Flex Joints, Anti-Wobble Joints and Pro Disconnect Joints

The Pro Series Krawler Joints, Pro Flex Joints, Anti-Wobble Joints and Pro Disconnect Joints are greaseable. They come pre-lubed from the factory. The grease valley is machined into the housings. Grade 1 grease can be used in all joints. They will not take a lot of grease nor do they need a lot of grease. Approximately every 4 to 6 months under normal operating conditions they should be greased. This is condition and use dependent so please use common sense. Over lubrication or using the incorrect grade of grease can do damage to the joints and hydraulically displace the race way material causing a sloppy joint condition. Never ever use red and tacky.

If the joint is not loose, it is not bad. Only if the ball is sloppy in the joint housing is it a bad joint and should be rebuilt. Krawler Joint Raceways, Pro Flex Joint Raceway, or Anti-Wobble Joint Raceways are available through Rock Krawler Suspension or an authorized dealer.

Please note: If you are not using the full range of motion of the Krawler Joint, Pro Flex Joint or Anti-Wobble Joint very often, the lubrication will not be moving inside the joint. In such cases we recommend spraying down the outside of the Joint with WD-40 or Liquid Fluid Film to ensure the race ways do not dry up. In highly corrosive environments it is also recommended to spray down the suspension components with WD-40 or Liquid Fluid Film. This will minimize corrosion of the components do to exposure to the elements.

HEIM JOINTS (Non- rebuildable spherical joints)

All Rock Krawler Heim Joints use Teflon Liners and thus are self lubricating. They too can also benefit from spraying down the outside of them liberally with WD-40 or Liquid Fluid Film. Grease should never be applied to them! Take caution when using cleaners and detergents on your vehicle as it can ruin the adhesives used on the Teflon liners yielding a bad heim joint!

THE USE OF ANTI SEIZE

If you are in a corrosive environment and would like to prevent rusting and or seizing of joints, Rock Krawler recommends the installer removes all thread in joints before installation to apply anti-seize inside the threaded connections. This will make future adjustments much easier if needed years down the road.

THE USE OF LIQUID FLUID FILM OR WD-40

If you are in a corrosive environment and would like to protect the finish of the underside of your vehicle, suspension components etc., Rock Krawler recommends cleaning thoroughly a few times during the winter months and applying Liquid Fluid Film or WD-40 to the underside of your vehicle. This will help minimize corrosion do to Rock Salt, Liquid Salt, Mag. Chloride and combination with sand and salt.

SUGGESTED STARTING LENGTHS

- 3.0" Front Track Bar Assembled Length = 34 5/16"
- 3.0" Front Lower Control Arm Assembled Length = 35 13/16"
- 3.0" Front Upper Control Arm Assembled Length = 35 1/8"
- 3.0" Rear Lower Control Arm Assembled Length = 23 3/4"
- 3.0" Rear Upper Control Arm Assembled Length = 24 5/16"

ROCK KRAWLER

S U S P E N S I O N

4.5" Front Track Bar Assembled Length (Stock Axle Mount) = 34 7/16"

4.5" Front Lower Control Arm Assembled Length = 35 7/8"

4.5" Front Upper Control Arm Assembled Length = 35 3/16"

4.5" Rear Lower Control Arm Assembled Length = 23 7/8"

4.5" Rear Upper Control Arm Assembled Length = 24 1/2"

*** For All 4.5" Systems if you are not upgrading to a high steer, before you head off-road we highly recommend you upgrade your drag link to the Steer Smarts XD Yeti Drag Link.**

Please Note:* All Control Arms, Track Bars, and Sway Bar Links come preassembled, but require adjustment to the above recommended starting dimensions. These measurements are taken from the center of one bolt hole to center of the other bolt hole (i.e. straight line). **Please check out our Rock Krawler Youtube Channel if need be for how to set the control arms properly and the importance of Jam Nuts...



TORQUE VALUES FOR HARDWARE AND JAM NUTS

- All 10mm and 3/8 bolts are torqued to **30-35 ft-lbs.**
- All 12mm and 1/2" bolts are torqued to **75-80 ft-lbs.**
- All 14mm and 9/16" bolts are torqued to **90-100 ft-lbs.**
- All 16mm and 5/8" bolts are torqued to **120-140 ft-lbs.**
- All 7/8" **Jam Nuts** are to be torqued **200-220 ft-lbs.** Up to 5/8" of threads showing past the jam nut is safe for final adjustment. These specifications are critical for the overall longevity of the threaded section.
- All 1" **Jam Nuts** are to be torqued to **250-300 ft-lbs.** GET YOUR BIG BOY PANTS ON! Up to 3/4" of threads showing past the jam nut is safe for final adjustment. These specifications are critical for the overall longevity of the threaded section.
- All 1 1/4" **Jam Nuts** are to be torqued to **275-325 ft-lbs.** GET YOUR BIG BOY PANTS ON! Up to 7/8" of threads showing past the jam nut is safe for final adjustment. These specifications are critical for the overall longevity of the threaded section.

FRONT OF VEHICLE (Perform all Steps for the System You Are Installing)

- 1) Make sure vehicle is on a level, hard working surface if you are using a floor jack and jack stands.
- 2) Block the rear wheels so the vehicle cannot move and make sure the emergency brake is applied.
- 3) Raise and support the front of the vehicle with safety jack stands. Place them on the frame in front of the axle.
- 4) If you are using a vehicle lift, place the lift arms according to those specific vehicles lifting procedures. Ensure that the lift arms will not interfere with the components that are being replaced.
- 5) Remove the front rims and tires with axle supported by a floor jack.
- 6) Remove the front shocks. Save the OEM hardware to install the new shocks.
- 7) Remove the nut holding the factory brake line to the OEM lower control arms. Clip the ties holding the pass. side disconnect motor cable from the passenger side front upper control arm and disconnect motor housing. Be sure to add slack to the breather tube as well.
- 8) Remove the metal bracket that held the factory brake line to the control arm from the brake line itself
Note: use 2 pair of vice grips, one pair to hold the bracket and one pair to peel the bracket back off the line.



Remove Brake Lines from Arms

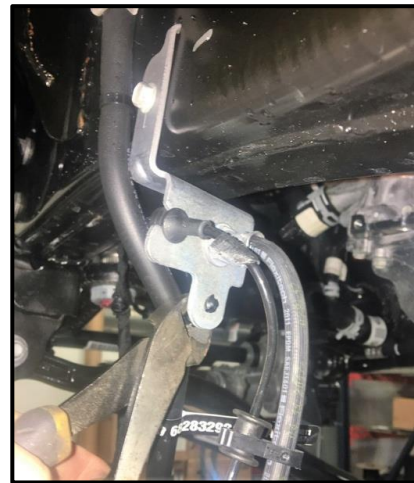

Clip for Breather Line Slack

ROCK KRAWLER

S U S P E N S I O N

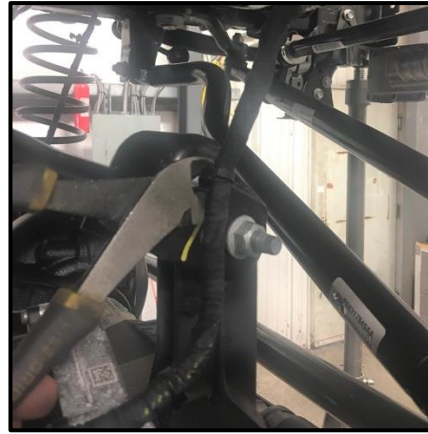

Remove the plastic clips holding the pass. disconnect motor cable from the upper arm and motor housing as shown

- 9) Lower the front axle assembly onto jack stands.
- 10) Remove the front track bar from the vehicle and save the OEM hardware for reuse.
- 11) **For the 3.5" and Taller Systems**, the drag link end will be your limiting factor without shocks to allow the axle to droop. For these systems, we recommend you separate the drag link from the knuckle connection to allow for ease of axle movement. Do not ignore, If the joint is damaged from overextension, adverse handling can result.



- 12) Remove the front springs from the vehicle.
- 13) Remove the front control arms from your vehicle.

ROCK KRAWLER

S U S P E N S I O N

- 14) To make servicing your front lower control arms easier and to have the Zerk fitting facing upward at the axle; we recommend you cut a little relief in the upper control arm mount as shown. A hole saw is a simple way to make a nice, clean cut. Then add some paint of your choice to minimize rust later on.

NOTE: CUSTOMERS WITH COIL OVER KITS – PLEASE SEE THE COIL OVER SUPPLEMENT AT THE END OF THE INSTRUCTIONS.



- 15) If you received or purchased separately the Rock Krawler front stackable bump stops, now is a great time to drill the lower bump stop pad with a 1/2" drill bit. Drill your hole in the center of the pad. We recommend 2 or 3 pads for 3.0" of lift and 3 or 4 pads for 4.5" of lift. Choose the proper 1/2" bolt.

ROCK KRAWLER

S U S P E N S I O N

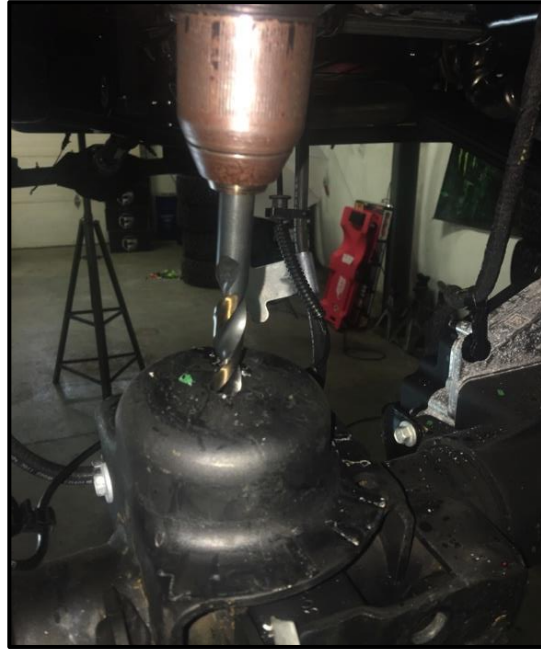

- 16) Remove the OEM spring isolators or spring seats on the axle and replace them with the supplied Rock Krawler spring seats. They are not side specific and use the locating pin on the axle to set their orientation. Please see below.



New Bottom Spring Seats Shown with Bump Stop Stack in Place

- 17) Moving to the front long arm mounts, remove the four downward facing bolts from the OEM cross member. Also remove the second cross member towards the front of the vehicle, closer to the engine.
- 18) Temporarily remove sections of the exhaust which will get in your way for the installation. This includes the driver's side loop and the passenger's side crossover pipe... Now you will have room to work. Save the hardware for this will be reused and needs to be put back together.

ROCK KRAWLER

S U S P E N S I O N

19) Begin to cut the upper and lower frame side mounts off the vehicle. Refer to the pictures below.

Please Note: There are different methods for removing stock brackets. In our shop we use reciprocating saws, cutting wheels, or plasma cutters for the welds.



Driver's Side Front Frame Rail

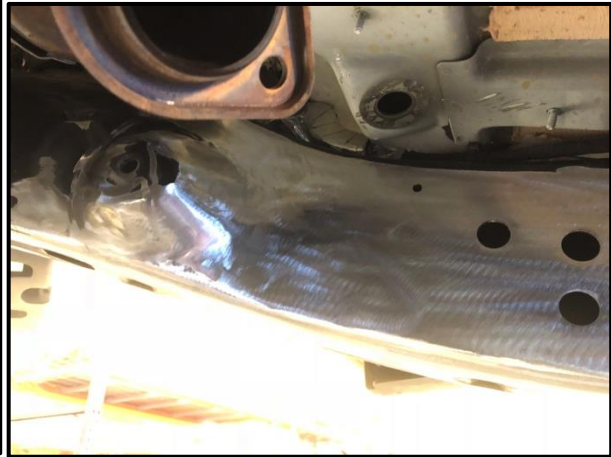

Pass's Side Front Frame Rail

Once most of the bracket is removed, use a worn-out flap disk to slowly smooth the frame until the bracket is no longer visible.

- Please note: Some JT frames have little weld bungs used for alignment during the factory welding of the frame for alignment purposes. Those will have to be trimmed cut off and smoothed as well for the new long arm mounts to sit flush against the frame.



20) Grab your new front long arm brackets and cross member. Lower the OEM Skid Plate and slide the supplied RK Cross Member/Long Arm Mount Kicker Brace between the OEM skid plate and the bottom of the cross member. Re-install the four bolts you previously removed. Then bolt the front mounts to the plate using supplied 1/2" carriage bolts, 1/2" lock washers, and 1/2" jam nuts. Be sure to push the long arm mounts tightly against the frame prior to welding.

ROCK KRAWLER

S U S P E N S I O N



Driver side bracket



Pass's side bracket

Weld continuously along the bracket according to the image below. Note that welding the top is optional – the bracket will have enough structural integrity without it. If you choose to weld, it will require lifting the body from the frame.

- 21) Weld the new heavy-duty frame side mounts on the inner frame. See the welding schedule below for the new long arm brackets. Use a 3/16" fillet weld along the portions highlighted in the drawing.

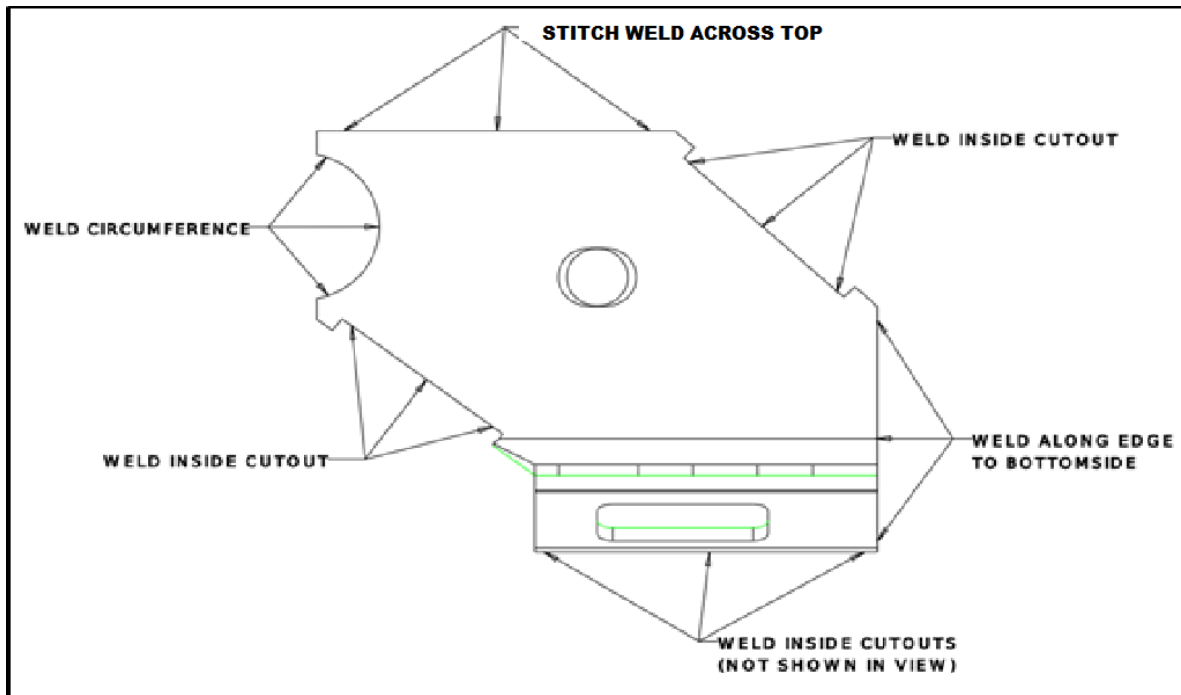

Weld Schedule for Front Mounts

ROCK KRAWLER

S U S P E N S I O N



Back Side Weld



Bottom Side Weld

- 22) After your brackets have been installed, apply a durable finish to the frame and bracket. Allow to dry before moving on.
- 23) **Critical Step:** Clean your brackets with rubbing alcohol and use the supplied heat shield/ sticky shield material to cover the bracket walls that will be closest the exhaust. We do this to protect the joints from overheating. Place the heat shield on all exterior walls close the joint. Model your heat taping from the pictures below.



Heat shield driver



Heat shield passenger

ROCK KRAWLER

S U S P E N S I O N

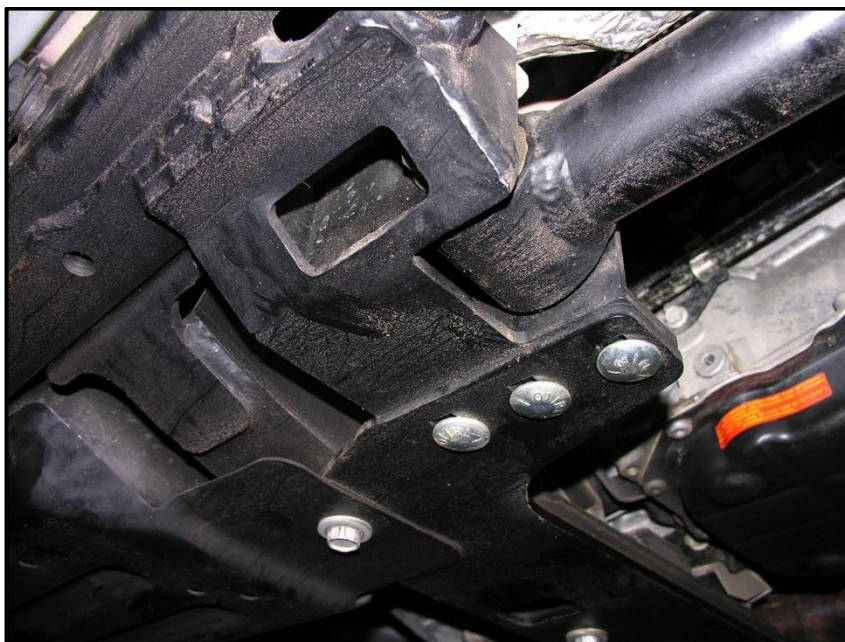

Finished long arm assembly (passenger side)

- 24) Set your upper arms to lengths specified on page 5 of the instructions. Install the upper control arms in your vehicle. Use the supplied 14mm x 100mm bolt, 14mm lock nut, and a 14mm washer on either side. Ensure the bends are oriented away from the exhaust as shown in the image below. Attach the frame side connection first with the supplied, then the axle side fork.

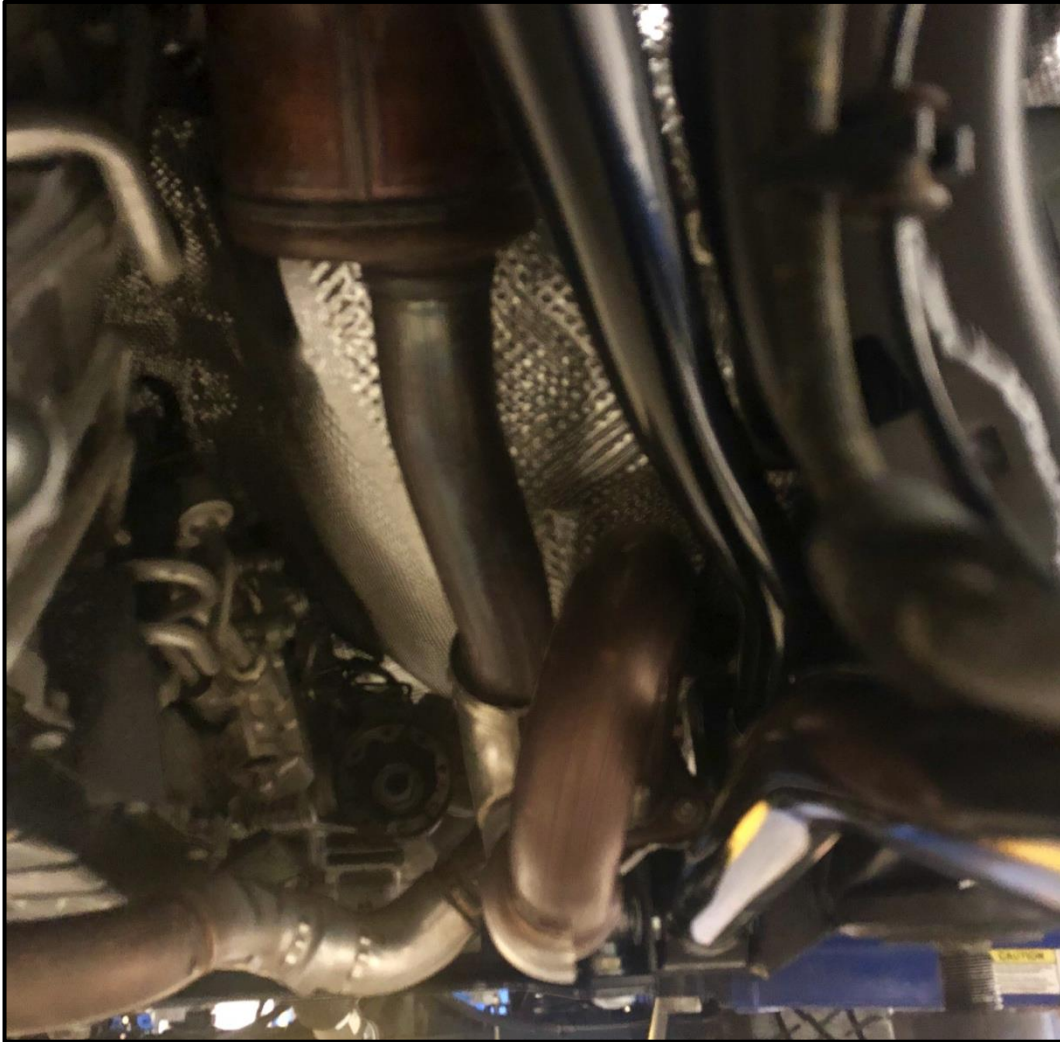

Bend orientation of front upper long arms

- 25) Install your Front Lower Control Arms. Set your front lower arms to the lengths specified on page 5 of the instructions. Use the supplied 5/8" x 4.5" bolt, 5/8" lock nut, and a 5/8" washer on either side. The Pro Flex joint (Welded End) will be attached at the frame side mount, and the Krawler joint (Adjustable Joint) will be attached to the axle. Zerk fittings are oriented upwards at both axle and frame. Please note: the bend in the arm goes up. It is a high clearance lower control arm, not a low clearance arm.
- 26) Re-install the exhaust into your vehicle.
- 27) Install the supplied front coil springs. Rotate the coil until the end winding seats into the rubber isolator pocket. If the coil is not seated properly it can possibly bow excessively. A critical detail is making sure the top OEM spring isolator is seated correctly with both rubber nipples sticking up through the holes in the OEM mount.
- 28) Install the front shocks re-using OEM hardware for the upper location. Reusing the shorter bolts from the OEM rear sway bar links for the lower shock mount instead of the OEM lower shock bolts is a better fit for this application and will ensure the bolt does not make contact with the high clearance bend portion of the control arm.

ROCK KRAWLER

S U S P E N S I O N

- 29) As you are compressing the suspension, install the front track bar reusing the OEM hardware. Be sure to set it to the starting dimensions for your system as specified on page 5. The rebuildable Anti-Wobble joint goes to the frame connection and the heim joint with high misalignment spacers goes to the axle (as shown below).

Helpful hint: Be sure to have the steering column unlocked so the axle will swing side to side freely.



Frame side track bar



Axle side track bar

- 30) Reattach the drag link to the passenger side knuckle.
- 31) Choose your front sway bar link package (Either Gen 2 Disconnects or No Limits Links (Rubicon Models)). For Gen2 Disconnects follow steps A and B. For No Limits Links follow step C.

ROCK KRAWLER

S U S P E N S I O N

A. For Gen 2 Sway Bar Disconnects.

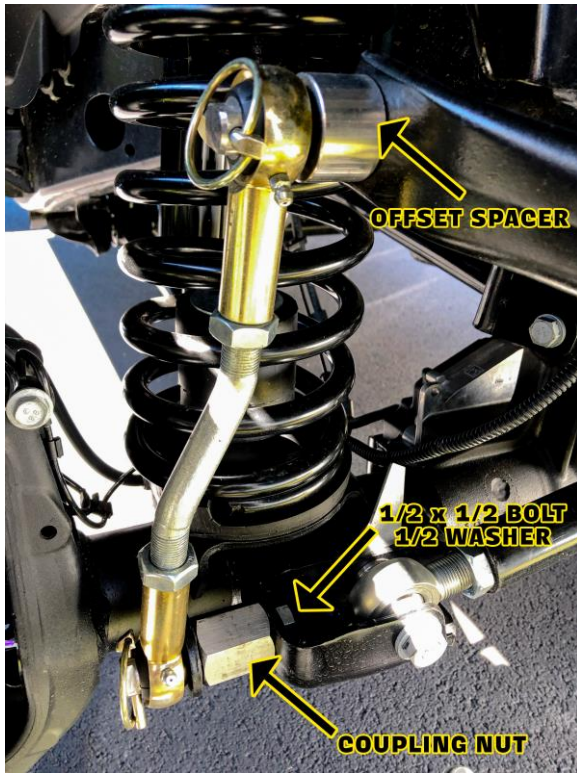

Pass. Side

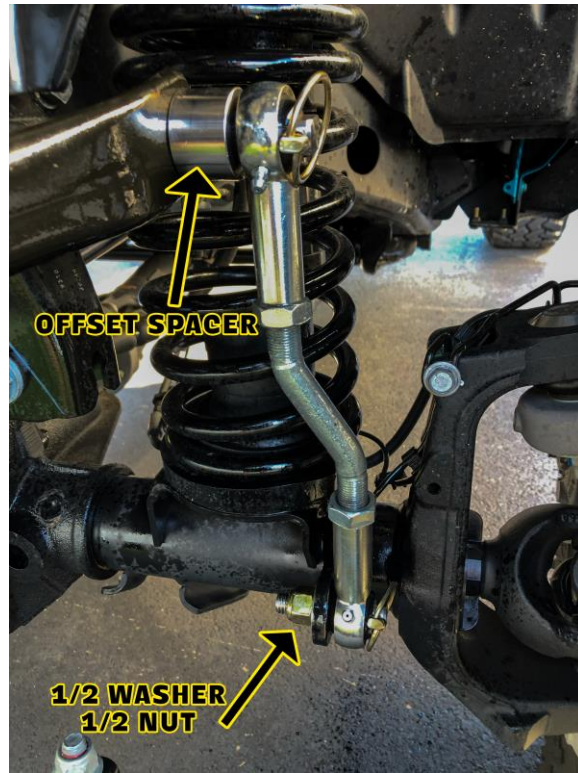

Driver Side

Recommended Starting Lengths 3.5" Systems 9 1/4" – 9 1/2" / 4.5" Systems 9.3/4" – 9 7/8"

For the Driver Side, the Offset Spacer with Disconnect Pin goes against the sway bar and is secured with a 1/2" washer and 1/2" nylok nut. The bottom disconnect pin gets secured to the outside of stock sway bar link mounting tab as shown with a 1/2" washer and 1/2" Nylok Nut.

For the Passenger Side, the Offset Spacer with the Disconnect Pin goes against the sway bar and is secured with a 1/2" washer and 1/2" nylok nut. The bottom disconnect pin threads into the stainless steel coupling nut as shown. From the inside of the track bar mount, tighten into the coupling nut the 1/2" bolt with 1/2" washer. **Helpful Hint:** Do not tighten to spec until all the hardware is installed. **Please note:** An extra 1/2 washer and nylok nut is included for the passenger side lower mount for aftermarket axle housings that will not support the coupling nut like the OEM housings do.

Slide the sway bar links on the disconnect pins top and bottom. **Helpful Hint:** lubricate the pins with WD40 or Liquid Fluid Film to make them easier to slide on and off the stainless steel disconnect pins.

Please Note: when locking the jam nuts, the offset in the sway bar link pin is to the outside of the vehicle as shown. Some aftermarket axle housings may not line up exactly like the OEM housings so you can rotate the center link to a front and back offset on those housings as needed.

Secure the removable sway bar links with the supplied Lynch Pins top and bottom.

ROCK KRAWLER

S U S P E N S I O N

B. To install your sway bar link straps use the supplied 5/16" Bolt, Washers and Nut to attach them as shown to the coil spring bucket. Or you can drill a hole in a more preferred place of your liking.



C. For No Limits Links

Set your sway bar links to the lengths below based on lift height. Torque the jam nuts to 60-75 ft-lbs with the joints in line with one another. This can be done in the vehicle.

Recommended Starting Lengths 3.0" Systems – 11.0" / 4.5" Systems - 12"

ROCK KRAWLER

S U S P E N S I O N



Passenger's side connection shown

Start with the side of your choice – Use the supplied 12mm x 70mm bolts, four washers and locknut for each side. Refer to the images below for the orientation of hardware. One washer connects the head of the bolt, that bolt goes through the sway bar link and through the sway bar hole. Then attach another washer followed by a locknut.

32) Tighten all connections per the recommended torque specs above.

33) Put the tires and wheels back on the front end and carefully lower the vehicle to the ground.

REAR OF VEHICLE (Perform all Steps for the System You Are Installing)

- 1) Make sure vehicle is on a level, hard, working surface if you are using a floor jack and jack stands
- 2) Block the front wheels so the vehicle cannot move.
- 3) Raise and support the rear of vehicle with safety jack stands. Locate jack stands on the frame behind the rear axle.
- 4) If you are using a vehicle lift, place the lift arms according to those specific vehicles lifting procedures. Ensure that the lift arms will not interfere with the components that are being replaced.
- 5) Remove the rear rims and tires with axle supported by a floor jack.
- 6) Remove the rear shocks. Save the OEM hardware for reuse.
- 7) Remove the OEM rear sway bar links and discard them for they will not be reused.
- 8) Remove the wire form retainer from the back of the axle on the ABS lines to add slack to the lines as shown below.



Brake Line Wire Form to be Removed

- 9) Lower the rear axle assembly onto jack stands.
- 10) Remove the rear coil springs.

ROCK KRAWLER

S U S P E N S I O N

- 11) Remove the OEM rear track bar and discard it.
- 12) Remove the rear upper control arms and save the OEM hardware for reuse.
- 13) Remove the rear lower control arms and discard them, save the OEM hardware for reuse.
- 14) Install the rear lower control arms set to the specified length for your kit according to our measurements using OEM hardware.

**Please Note:* The bend in the arms is for improved ground clearance and goes up. The Krawler Joint (Zinc Plated Spherical Joint) goes to the axle and the Bushing Joint goes to the frame. Do not allow more than 3/4" of thread to show past any jam nut for proper thread engagement. Same as the front lower control arms.
- 15) Install the spring seats on the axle. The thick part of the spring seats goes toward the rear of the vehicle and is marked **R**. The thin part is marked **F** for front. There is a specific driver and passenger side marked by a **1** and **2** on the bottom of the spring seats.

The thicker spring seat marked **2** on the bottom goes on the passenger side axle mount. The thinner spring seat marked **1** on the bottom goes on the driver side axle mount.

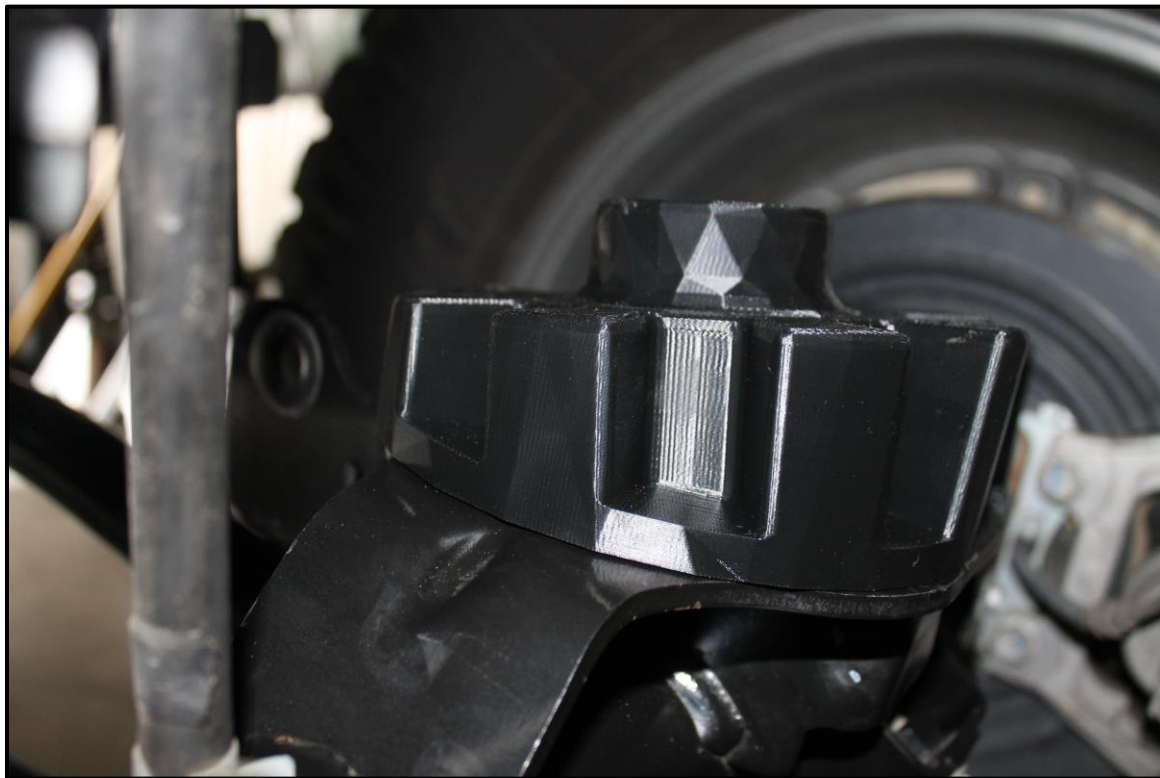

Pass. Side Rear Spring Seat Shown Installed

**Please note: When Installed with the coil springs at ride height with the pinion angle set properly, these spring seats return the lower coil seat to a neutral or level position. This is their primary function which minimizes rear spring bow. The difference in thickness accounts for most common asymmetrical loading conditions or compensates for vehicle lean while maintaining the same coil spring side to side for optimal performance.*

ROCK KRAWLER

S U S P E N S I O N

16) Install the rear cradle.

A. Drill out the OEM holes in the axle housing with the supplied drill bit. Then tap the holes with the supplied 1/2-13 hand tap.

B Bolt the rear cradle to the top of the axle housing using the supplied 1/2 - 13 x 1.5" long bolts and spiral lock washer. Be sure to put the front brake line bracket on top of the rear truss using the holes it was installed in prior. Tighten these bolts first. This will suck the rear truss down so it sits flush prior to tightening the u-bolts.

C. Using the supplied U-Bolts, spiral lock washers and nylok nuts, tighten the u bolts securing the rear cradle to the axle tubes.

Please note: per Dana recommendations, if you are running larger than 37" tall tires or are going to be using your JT hard core off road, they are requesting the rear cradle be fully welded to the axle tubes as well prior to any hard core off road use.



Rear Cradle Top View



Rear Cradle Back View

17) Install the rear upper arms using the OEM rear upper control arm hardware. Please note: there is a driver side and passenger side rear upper arm assembly. The Pro Flex Bushing goes to the frame connection and the adjustable Krawler Joint end goes to the rear cradle. The bend in the arm goes down on each side. One side to clear the exhaust and the other side to clear the charcoal canister. Use the starting dimensions from above and adjust each arm symmetrically to maintain the rear axle perfectly centered. Do not allow more than 7/8" of thread to show past any jam nut for proper thread engagement.

18) Install the Rock Krawler rear coil springs. Make sure to put the closer wound coils go up and the end coil winding is sitting in the top spring seat properly. Please note: the top spring seats are indexed as well with a pin to set their orientation. This too must be correct.

For those that opted to go with a 4.5" Systems; Install the optional Carrier Bearing Drop Kit if needed.

19) Install the rear shocks using the OEM hardware.

20) If purchased separately or included in your system, install the RK fabbed rear bump stops. Our rear fabricated bump stops mount to the factory bump stop pad using the supplied 3/8 x 3/4 bolts, washers, and nylok nuts. Bolt up two of the holes, mark two of the holes and drill them with a 3/8 drill bit.

ROCK KRAWLER

S U S P E N S I O N

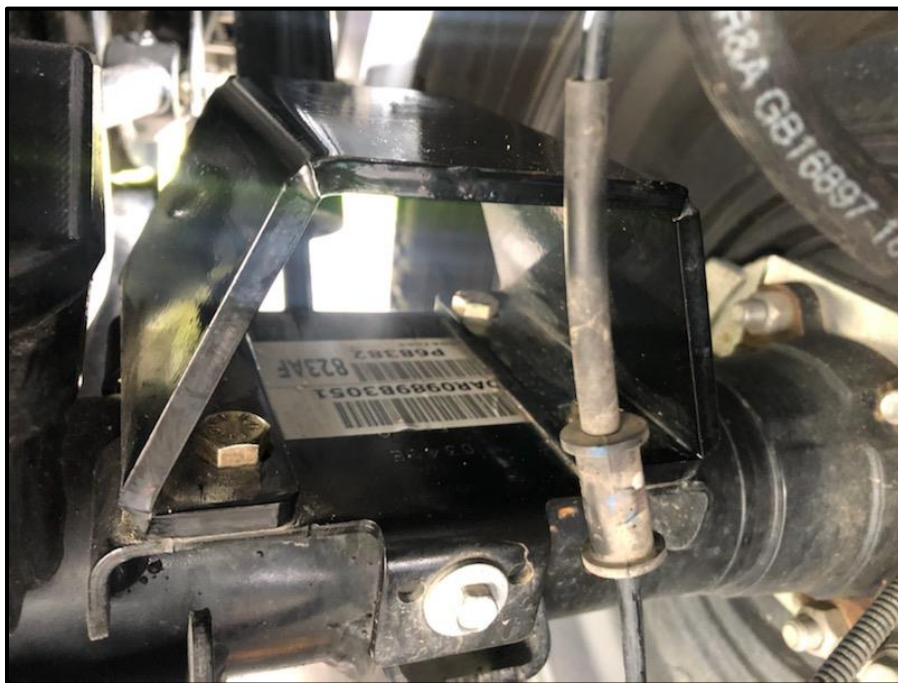

Pass. Side Rear Bump Stop Pad Installed

21) Install the Supplied Pro Rear Sway Bar Links

Set the assembled length to 12.5" for the 3.0" systems and 14.0" for the 4.5" Systems.

- A) The Bottom Mount gets secured with the supplied 12mm Bolt, Large Washer and Nylok Nut. The Large Washer goes on the outside of the ball as shown to retain the ball and socket joint. Set the assembled length to 13".



Rear Sway Bar Link Bottom Connection

- B) The top connection reuses the factory rear upper sway bar link bolt and again, the large washer goes against the ball to retain the ball and socket joint.



Rear Sway Bar Link Top Mount

ROCK KRAWLER

S U S P E N S I O N

- 22) For all 4.5" Systems, install the supplied stainless steel brake lines. Follow the Service Manual for your Gladiator for installation and or bleeding the brake system and ABS brake module.
- 23) Install the rear wheels and tires and lower the vehicle to the ground.
- 24) Tighten all mounting bolts at this time!

Recommended Alignment Specs are as follows:

3.0"/4.5" Lift Height: 5.0 to 6.0 degrees of Caster with a .2 to .4 Cross Caster Split
.2 to .4 degrees more caster on the pass. side than the driver's side.

Tow: Factory specifications

The rear pinion angle should be down 2 – 3 degrees from the driveshaft as shown.

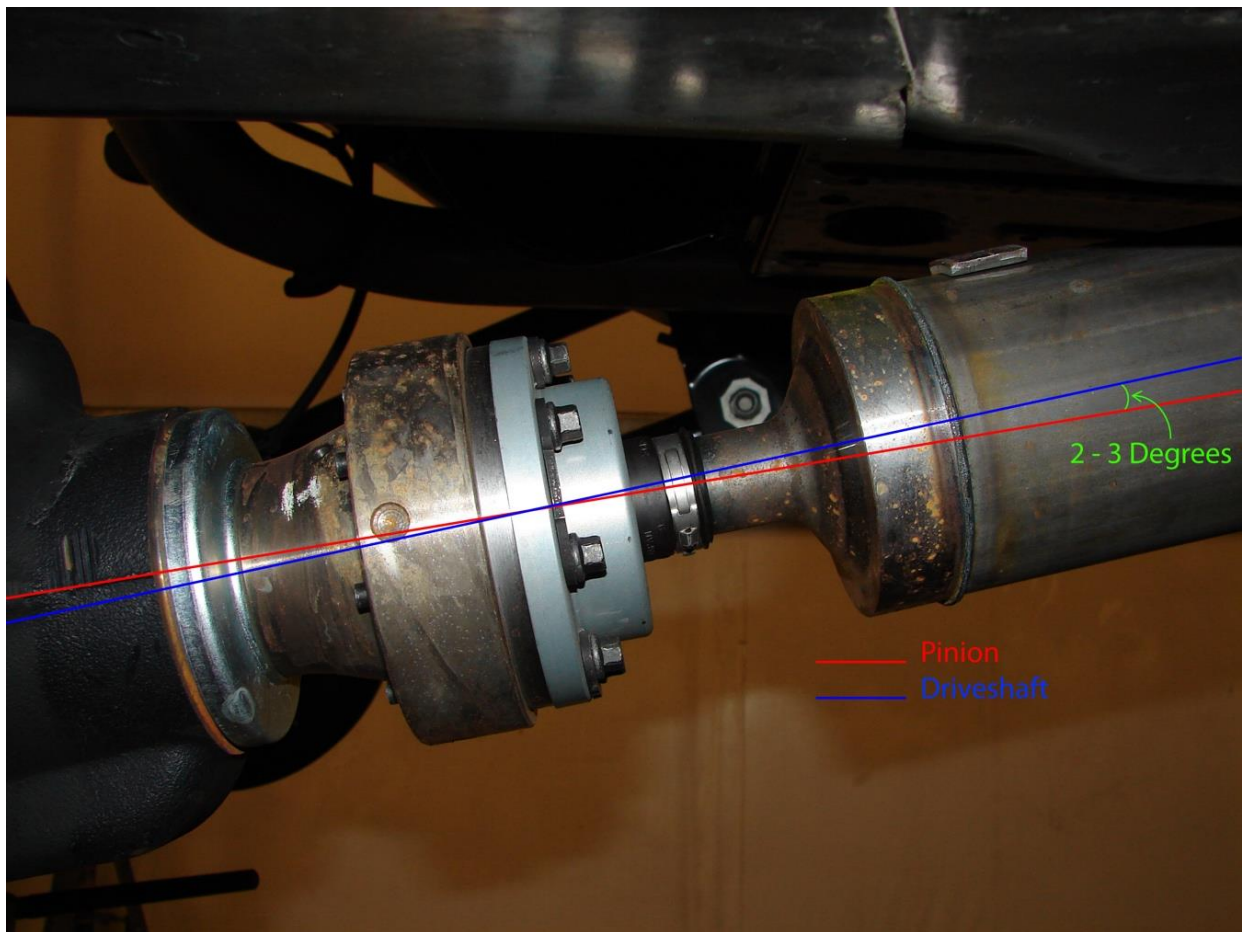



A note about tires, wheels, tire pressure and how it effects ride quality:

Tire and Wheel combinations at a given tire pressure have their own spring and dampening rates associated with them. This plays a major part in ride quality and off-road performance. The stock tire pressure settings on your Wrangler are based on stock C rated light duty tires on 17" wheels. Larger aftermarket tires typically have a much firmer side wall than the stock ones, thus increasing the spring rate and decreasing the dampening rate associated with the tires themselves. Going from a C to a D or E rated tire also amplifies this effect. Increasing wheel diameters cuts down on the sidewall size of the tire; for example going from a 17" wheel to a 20" to 22" wheels will increase the spring rate and decrease the dampening rate of the tire and wheel combination. As you increase tire strength and wheel size it is common to have to reduce the tire pressures in order to make your aftermarket tire and wheel combination feel like a stock wheel and wheel combination.

Choose pressures wisely and safely! This is one part of your suspension tuning you can do on your own.

Before hitting the pavement or the trails be sure to make sure the control arms are oriented properly, all spherical joints (heim joints and Krawler Joints) are oriented correctly to allow for maximum movement without bind, and all jam nuts have Loctite on them and are tight. Make sure the axles are properly centered, pinion angles are correct, there is proper slack in ABS lines, and all lines are properly routed. Go back over all your hardware and make sure each connection is tightened to its proper torque spec. Check your vehicles articulation and ensure that no moving parts contact or interfere with any other components throughout the travel (brake lines, shocks, coils, sway bar links). Also check to see if at full flex your coil spring losses tension, if so you may want to look into a limit straps. You may need to look at bump stops depending on what shocks you choose to run.

Congratulations, you have just finished installing your Rock Krawler Suspension System! Your Jeep is now free to roam about the country.



Common Service Parts Listings:

Grade 1 Grease such as Mobil Grease – Mobilux EP1 [NLGI 1] or equivalent can be used for Systems After Jan 1 2020.

Front and Rear Lower Control Arms Prior to 3/1/2021

Pro Flex Bushings (Frame End) – RK04838K – Requires Large Joint Tool – RK04484

Lower Control Arm Full Replacement Krawler Joint (Axle End) – RK05067

Lower Control Arm Krawler Joint Rebuild Bushings – RK04034K – Requires Large Joint Tool – RK04484

Front and Rear Lower Control Arms After to 3/1/2021

Lower Control Arm Adventure Series Joint (Frame End) – RK07404K

Lower Control Arm Full Replacement Krawler Joint (Axle End) – RK5067

Lower Control Arm Krawler Joint Rebuild Bushings – RK04034K – Requires Large Joint Tool – RK04484

Front Track Bar Prior to 1/1/2021 (RK06187)

Anti-Wobble Joint Bushings (Frame End) – RK07836K – Requires Small Joint Tool – RK04487

Replacement Heim Joints (Axle End) – RK03426 (7/8 Shank) – Optional New Misalignment Spacers – RK03428

Front Track Bar After to 1/1/2021 (RK06187HD)

Anti-Wobble Joint Bushings (Frame End) – RK07836K – Requires Small Joint Tool – RK04487

Front Track Bar Replacement Heim Joint (Axle End) – RK07535 (1” Shank) – Optional New Misalignment Spacers – RK03428

Front Upper Control Arms:

Replacement Krawler Joint – RK04153

Replacement Krawler Joint Bushings – RK04034K – Requires Large Joint Tool – RK04484

Rear Upper Control Arm Prior to 3/1/2021

Pro Flex Bushings (Frame End) – RK04838K – Requires Large Joint Tool – RK04484

Lower Control Arm Full Replacement Krawler Joint (Axle End) – RK05067

Lower Control Arm Krawler Joint Rebuild Bushings – RK04034K – Requires Large Joint Tool – RK04484

Rear Upper Control Arm After 3/1/2021

Lower Control Arm Adventure Series Joint (Frame End) – RK07404K



Lower Control Arm Full Replacement Krawler Joint (Axle End) – RK5067

Lower Control Arm Krawler Joint Rebuild Bushings – RK04034K – Requires Large Joint Tool – RK04484

ROCK KRAWLER

S U S P E N S I O N

For the Optional Coil Over Systems and or Upgrades and Rear Big Boy Shocks Please Do The Following!

- 1) Remove the stock shock brackets from your Jeep. It's easiest to score the weld marks and cut the OEM shock tower into pieces. Be sure not to cut any important hoses or wires behind the shock tower. Re-paint any exposed areas with a durable coating after the towers have been removed.



Passengers Side Bracket Removed

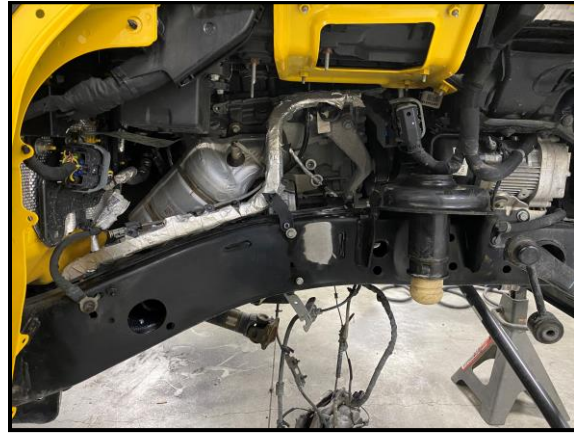

Drivers Side Bracket Removed

- 2) Make sure to bend the driver's side bracket upwards before test fitting your coil over towers. This will stop the new towers from hitting.



- 3) Test-fit your coil over brackets as shown below. Clamp the mount about the oval frame side hole and center punch one of the 1/2" holes. Remove the tower and drill out one 1/2" hole on the side of the frame. After that, center the coil over mount on the spring tower and drill three 7/16" holes in the spring tower.

ROCK KRAWLER

S U S P E N S I O N



- 4) Bolt the tower down. The two frame connections get $\frac{1}{2}$ " x 1.25" bolts, two washers and a locknut each. The three spring tower connections get $\frac{7}{16}$ " screws, two washers and one locknut each.
- 5) Next, remove the OEM bottom shock mount from the frame. You may need to use a Dremel in order to get the last of the mount off the axle cleanly.
- 6) Set the caster on the axle to 5 degrees as shown below before welding on the new lower coil over mounts. Keep the axle at that angle for the proceeding steps. Measure from the top ball joint surface.



ROCK KRAWLER

S U S P E N S I O N

- 7) Grind the powder coat off the new mounts in all applicable weld surfaces. Measure $\frac{3}{4}$ " away from the inner C for Rubicon models as shown below. For Non-Rubi models, bring the new mount as close to the axle C as possible. This is because JL Rubi Axle WMS is 68.00"/ JL Sport/Sahara WMS is 66.50".



***Please Note:** For some axle housings you may have to trim the OEM spring bucket at the axle for proper coil over shock clearance.

- 8) While the axle caster is set to **5 Degrees**, set the top surface of the lower coil over mounts to **0 Degrees**. Make sure the outward spacing from the "C" and angle of zero are correct before you weld these mounts. After, apply a durable finish of your choice to the bracket to prevent corrosion.

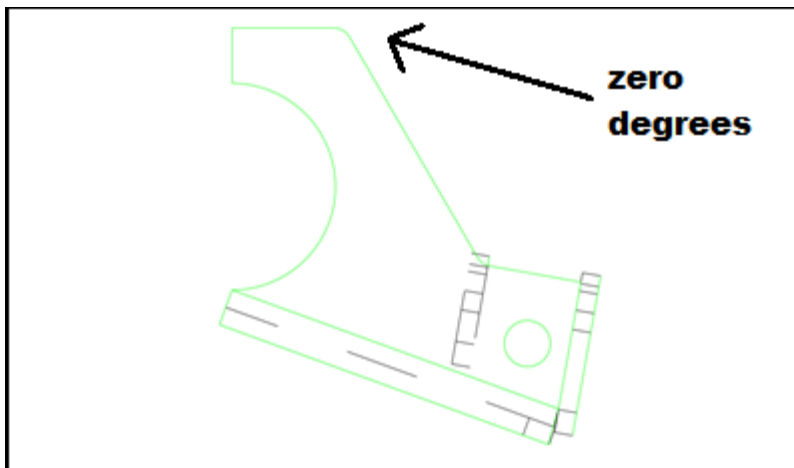

- 9) Test fit the coil over into the vehicle. With the front coil overs, ensure the coil over with more preload attached to the passenger's side. (to account for added weight from the gas tank).

ROCK KRAWLER

S U S P E N S I O N



- 10) Place the supplied spacer on the top coil over connection on the inside of the bearing. Then secure the top connection with a $\frac{1}{2}$ " x 3.25" bolt with a washer on each side and locknut on the backside. Then place the $\frac{1}{2}$ " x 2.75" bolt through the bottom connection with a washer on each side, locknut on the back.

These mounts are designed as large shock mounts as well as coilover mounts. The spacer simply make this coilover compatible.