

ROCK KRAWLER S U S P E N S I O N

INSTALLATION MANUAL

FOR

ROCK KRAWLER SUSPENSION, INC.

**JL/JLU ADVENTURE X2
and X2 LONG ARM SYSTEMS**

2024 2nd EDITION

10/20/24



ROCK KRAWLER

S U S P E N S I O N

Dear Customer: Thank you for purchasing the best system on the market for your Jeep Vehicle. We are sure you will be happy with this system after your installation is complete. Please take your time during the installation and be sure to do it correctly. Completely read the directions before starting your installation so you know what to expect. Remember, your personal safety depends on it. Should you have any questions during this installation feel free to give our tech line a call and we will be happy to help you. (518-270-9822)

Welcome to TEAM RK

Share your before & after pictures, install photos & wheeling images.

facebook



@RKSuspension

Instagram

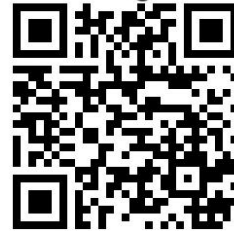

@rock_krawler

Note: BE SURE TO CHECK ALL FASTENERS FOR PROPER TORQUE BEFORE TEST DRIVE. RECHECK AFTER 500 MILES AND BE SURE TO CHECK PERIODICALLY.

WARNING

- Properly block and secure vehicle prior to installation.
- Always wear safety glasses when using power tools.
- Rock Krawler Suspension recommends the use of Loctite on all hardware, unless noted otherwise.
- The use of limiting straps is recommended to avoid damage from overextending the suspension of your vehicle.
- Read and understand all instructions, warnings and safety precautions in these instructions and your owner's manual before attempting to install these components.
- Proper installation of Rock Krawler Suspension products requires knowledge of recommended procedures for disassembly/assembly of OE vehicles and components. Access to OE shop manuals and special tools are required. Attempting to install this kit without knowledge of these procedures may affect the safety of your vehicle and or the performance of these components. Rock Krawler Suspension, Inc. strongly recommends that this system be installed by a certified mechanic with off-road experience.
- Rock Krawler Suspension does not recommend combined use of suspension lifts, body lifts or other lift devices. Combined use of lifts may result in unsafe and unexpected handling characteristics. Also, many states now have laws restricting Vehicle lift, bumper heights, and other alterations. Consult local laws to determine if your proposed alterations (including installation of this system) comply with your state laws.
- Rock Krawler Suspension does not condone or authorize the use of any other suspension components with its products. Should Rock Krawler Systems or components be installed in junction with other products or not per the provided instructions Rock Krawler Suspension warranty is void and is not to be held accountable for any resulting actions.

ROCK KRAWLER

S U S P E N S I O N

Driving and Handling Tips

- For Highway driving it is best to have the front and rear sway bar connected. This will give you the on-highway ride and handling characteristics you expect. **If you choose otherwise, you do so at your own risk.**
- The ride quality and handling that Rock Krawler is known for is based on using OEM sway bars front and rear with approved shocks. Using any components other than directed can result in adverse handling characteristics and poor ride quality.
- For Off-Road use it is best to have the front sway bar disconnected and the rear sway bar connected. This will allow your suspension to do its intended function. Our suspension will give your vehicle unmatched articulation which will provide traction and feedback to keep your vehicle moving in almost all conditions. Let the suspension do the work! Even if you are a Rubicon Owner for most situations, we recommend manually disconnecting the front sway bar.

IMPORTANCE OF JAM NUTS

This is a note about jam nuts and the consumer's responsibility. The installer is the person or persons initially responsible for the proper setup of the suspension system and/or components and the initial tightening of the jam nuts. The jam nuts not only hold the orientation of the joint it is on, but it is the single component that puts the necessary pre-load on the joint's threads. The consumer or vehicle owner is the person or persons responsible for maintaining the jam nuts tightness. Failure to do so will result in the rapid deterioration of the threads in the control arm and will impose a "cause for concern" for the occupants of the vehicle. Failure to comply with the warnings heeded in the directions regarding the number of threads showing past the jam nut will also result in the same "cause for concern" for the occupants of the vehicle. All of the above items are the responsibility of the vehicle owner and or installer. If a threaded section of a component is bad it will show itself defective immediately. Threads that fail over time are due to improper maintenance of jam nuts and can be proven very easily. Thread sections and jam nuts not properly maintained or set up, are not covered under warranty. This is the end user and installer's responsibility.

ORIENTATION OF JOINTS

Orient the Joint for maximum amount of movement with the head of joint perpendicular to bolt / head of the joint vertical in the mounting bracket. This same rule for orientation needs to be followed for all heim joints. The photo below shows the right way (LEFT SIDE) and the wrong way (RIGHT SIDE) to orient a joint.

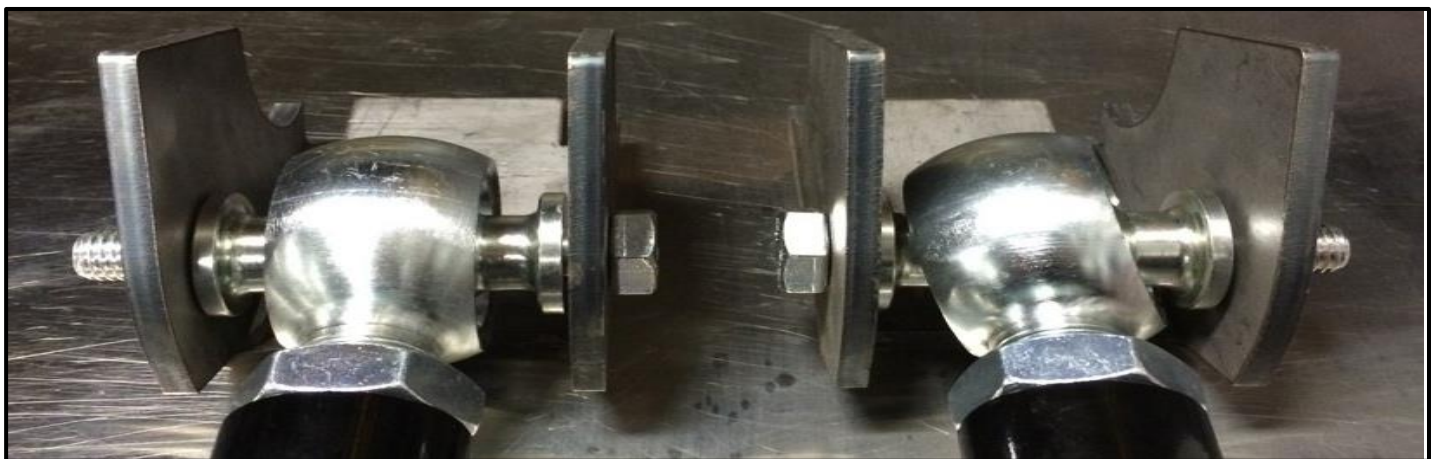

^RIGHT WAY^

^WRONG WAY^

ROCK KRAWLER S U S P E N S I O N

MAINTAINING JOINTS

Krawler Joints, Anti-Wobble Joints, and Pro Disconnect Joints

The Pro Series Krawler Joints, Pro Flex Joints, Anti-Wobble Joints and Pro Disconnect Joints are greaseable. They come pre-lubed from the factory. The grease valley is machined into the housings. Mobilux EP1 Grade 1 grease can be used in all joints. They will not take a lot of grease, nor do they need a lot of grease. Approximately every 4 to 6 months under normal operating conditions they should be greased. This is condition and use dependent so please use common sense. Over lubrication or using the incorrect grade of grease can do damage to the joints and hydraulically displace the race way material causing a sloppy joint condition. Never ever use red and tacky.

If the joint is not loose, it is not bad. Only if the ball is sloppy in the joint housing is it a bad joint and should be rebuilt. Krawler Joint Raceways, Pro Flex Joint Raceway, or Anti-Wobble Joint Raceways are available through Rock Krawler Suspension or an authorized dealer.

Please note: If you are not using the full range of motion of the Krawler Joint, Pro Flex Joint, or Anti-Wobble Joint very often, the lubrication will not be moving inside the joint. In such cases we recommend spraying down the outside of the Joint with WD-40 or Liquid Fluid Film to ensure the race ways do not dry up. In highly corrosive environments it is also recommended to spray down the suspension components with WD-40 or Liquid Fluid Film. This will minimize corrosion of the components due to exposure to the elements.

HEIM JOINTS (Non- rebuildable spherical joints)

All Rock Krawler Heim Joints use Teflon Liners and thus are self-lubricated. They too can also benefit from spraying down the outside of them liberally with WD-40 or Liquid Fluid Film. Grease should never be applied to them! Take caution when using cleaners and detergents on your vehicle as it can ruin the adhesives used on the Teflon liners yielding a bad heim joint!

THE USE OF ANTI SEIZE

If you are in a corrosive environment and would like to prevent rusting and/or seizing joints: Rock Krawler recommends the installer removes all thread in joints before installation to apply anti-seize inside the threaded connections. This will make future adjustments much easier if needed years down the road.

THE USE OF LIQUID FLUID FILM OR WD-40

If you are in a corrosive environment and would like to protect the finish of the underside of your vehicle, suspension components etc. Rock Krawler recommends cleaning thoroughly a few times during the winter months and applying Liquid Fluid Film or WD-40 to the underside of your vehicle. This will help minimize corrosion due to Rock Salt, Liquid Salt, Mag. Chloride and combination with sand and salt.

Tools

An installation of this caliber requires the use of a broad range of general hand tools. Do not attempt this installation if you do not have a basic tool set and understand how to use them. Beyond your typical wrenches, socket set, pry bars, hammers, etc. there are a few unique tools you may not realize will be helpful.

- Hole saw or Step bit up to 1.5 inch and angle drill
- Tin snips/ end nippers
- C Clamps
- Paint Pen/ Marker
- Angle Grinder with cut off wheels, sanding disks and flap wheels. Plasma torch is helpful but not required
- Welder (required)
- Pickle fork (if removing Drag link)

ROCK KRAWLER

S U S P E N S I O N

SUGGESTED STARTING LENGTHS

Measured from Bolt hole to Bolt hole in a straight line not along the bar

Front Track Bar – RK06187HD

3.5” lift (stock axle bracket)– 34 5/16”
4.5” lift (stock axle mount)– 34 7/16”
4.5” lift (raised axle bracket RK08236K)– 34 1/4”

Front Lower Control Arms

(AX2 – RK08442) (X2 – RK07145B)

3.5” lift heights – 35 13/16”
4.5” lift heights – 35 7/8”

Rear Lower Control Arms

(AX2 – RK08442) (X2 – RK07337B)

3.5” lift heights – 36 3/16”
4.5” lift heights – 36 1/4”

Front Sway bar links – 2024 Requires special hardware

3.5” lift heights – 11.25” (No limit links RK07346K)
4.5” lift heights – 12” (No limit links RK07346K)
3.5” lift heights – 9.25” (Gen 2 links RK07331K)
4.5” lift heights – 9.75” (Gen 2 links RK07331K)

Rear Track Bar - RK06692B

3.5” lift (w/ bracket RK06718K) – 37 13/16”
4.5” lift (w/ bracket RK06718K) – 37 7/8”

Front Upper Control Arm(s)

(AX2 – RK08385) (X2 – RK07342)

3.5” lift heights – 35 1/8”
4.5” lift heights – 35 3/16”

Rear Upper Control Arm

(AX2 – RK08444) (X2 – RK07339)

3.5” lift heights – 28 9/16”
4.5” lift heights – 28 5/8”

Rear Sway Bar links (RK05185)

3.5” lift heights – 12.5”
4.5” lift heights – 13”

****Please Note:*** All Control Arms, Track Bars, and Sway Bar Links come preassembled, but require adjustment to the above recommended starting dimensions. These measurements are taken from the center of one bolt hole to center of the other bolt hole. **Please check out our Rock Krawler YouTube Channel if necessary, for how to set the control arms properly and the importance of Jam Nuts...**



Please Note: The front upper arms can be tricky to set properly. Measure from the center of the mounting bolt to the center of the joint as shown for Adventure X2 Long Arms.



TORQUE VALUES FOR HARDWARE AND JAM NUTS

- All **10mm and 3/8 bolts** are torqued to **30-35 ft-lbs.**
 - All **12mm and ½” bolts** are torqued to **75-80 ft-lbs.**
 - All **14mm and 9/16” bolts** are torqued to **90-100 ft-lbs.**
 - All **16mm and 5/8” bolts** are torqued to **120-140 ft-lbs.**
 - All **7/8” Jam Nuts** are to be torqued **200-220 ft-lbs.** Up to 5/8” of threads showing past the jam nut is safe for final adjustment. These specifications are critical for the overall longevity of the threaded section.
 - All **1” Jam Nuts** are to be torqued to **250-300 ft-lbs.** GET YOUR BIG BOY PANTS ON! Up to 3/4” of threads showing past the jam nut is safe for final adjustment. These specifications are critical for the overall longevity of the threaded section.
 - All **1 1/4” Jam Nuts** are to be torqued to **275-325 ft-lbs.** GET YOUR BIG BOY PANTS ON! Up to 7/8” of threads showing past the jam nut is safe for final adjustment. These specifications are critical for the overall longevity of the threaded section.
-
- ❖ **Please note: You will be needing to convert your rear shocks from offset top to narrow width sleeve.**
 - ❖ **Exhaust modifications may be required.**
 - ❖ **If using Rock Krawler Front Coil Over Tower you may need to relocate the AUX battery (Diesel and 392 applications). 392 applications you will have to relocate the vacuum canister on the fire wall as well.**
 - ❖ **X2 Suspension requires an aftermarket Front Axle with no FAD**
 - ❖ **For All 4.5” Systems if you are not upgrading to a high steer, before you head off-road, we highly recommend you upgrade your drag link to the Pro X Drag Link.**
 - ❖ **2024 Front Sway bar links require special hardware.**
 - ❖ **If installing on a 392 or XR package on stock axle with taller bump stops the rear alignment tool needs to be spaced down accordingly to account for the rear bump stop pad height of 1.125” for everything to setup correctly.**

ROCK KRAWLER

S U S P E N S I O N

FRONT OF VEHICLE (Perform all Steps for the System you are installing)

- 1) If you are using a floor jack and jack stands, make sure vehicle is on a hard, level, working surface, then, block the rear wheels so the vehicle cannot move and make sure the emergency brake is applied.
- 2) Raise the front of vehicle. Support with safety jack stands. Locate jack stands on the frame in front of the axle. If you are using a vehicle lift, place the lift arms according to those specific vehicles lifting procedures. Ensure that the lift arms will not interfere with the components that are being replaced.
- 3) Remove the front wheels and tires with axle supported by a floor jack.
- 4) Remove the front shocks and discard. Save the OEM hardware to install the new shocks.
- 5) Do not overextend the front drive shaft. Disconnect the front driveshaft from axle and mark holes to reassemble in the same orientation if needed. Secure out of the way.
- 6) Lower the front axle assembly onto jack stands.
- 7) Remove the front sway bar links and discard.
- 8) Remove the front track bar from the vehicle, discard and save the OEM hardware for reuse.
- 9) The drag link end will be your limiting factor without shocks to allow the axle to droop. We recommend you separate the drag link from the knuckle connection to allow for ease of axle movement. If the joint is damaged from overextension, adverse handling can result.



ROCK KRAWLER

S U S P E N S I O N

10) Remove the nut holding the factory brake line to the OEM lower control arms. Clip the ties holding the pass. side disconnect motor cable from the passenger side front upper control arm and disconnect motor housing. Be sure to add slack to the breather tube as well.

11) Remove the metal bracket that held the factory brake line to the control arm from the brake line itself.

Note: Use 2 pairs of vice grips, one pair to hold the bracket and one pair to peel the bracket back off the line.



Remove Brake Lines from Arms



Clip for Breather Line Slack



Remove the plastic clips holding the pass. disconnect motor cable from the upper arm and motor housing as shown



12) Remove the front springs and OEM bottom spring seats and discard. Retain the stock upper isolators for reuse. Neutral upper isolators are required if you are doing Big Boy shocks with coil and shock in front. (RK08244K) They can be added also if you find the springs bow in towards the frame after a professional alignment. Install the Rock Krawler front lower correction wedges on axle (RK06705K). They are not side specific and use the locating pin on the axle to set their orientation. Please see image below with them installed.

13) Remove the front lower control arms and discard, save the hardware for reuse.

14) Remove the front upper control arms and discard arms and hardware.

15) Set all the new control arms, sway bar links and track bars to lengths.

ROCK KRAWLER

S U S P E N S I O N

- 16) If doing big boy shocks, you will have to remove the axle shock mount. Refer to coilover tower instructions at the end of this booklet. The shock will also change from stud top to through bolt.
- 17) Clearance the lower control arms with a 1.50" hole saw or grinding wheel. Or go with our heavy-duty weld on front lower control arm mounts. (RK00396) Paint any exposed metal after.



- 18) If you received or purchased the Rock Krawler front stackable bump stops, now is a great time to drill the lower bump stop pad with a 1/2" drill bit. Drill your hole in the center of the pad. We recommend 3 pads for 3.5" of lift and 4 pads for 4.5" of lift. Choose the proper 1/2" bolt.



New Bottom Spring Seats Shown with Bump Stop Stack in Place

- 19) **For the X2 Long arm ONLY, otherwise skip to step 22.** This requires an aftermarket axle, as JL Axles have an electronic front axle disconnect (FAD). Remove the passenger front upper mount, mark the centerline of the bolt hole, and remove the OEM mount. Clean bracket where it touches axle tube.

ROCK KRAWLER

S U S P E N S I O N



- 20) Prep the bracket and the axle for welding. The centerline of the bracket goes right where the OEM mount was and the position you marked. To orient the mount, the front flat surface should be parallel to the front track bar mounting surface or at 0 degrees with the axle set to 5-6 degrees of caster.
- 21) Weld the mount completely where the legs of mount touch axle and paint with a finish of your choice. This mount fits axles from stock to 4" tube. Some fabrication may be required.
- 22) Prepare the frame side front long arm mounts for installation. Pictures on following page.
 - a) Remove the four downward facing bolts from the OEM crossmember. Also, remove the second cross member towards the front of the vehicle, closer to the engine.
 - b) Temporarily remove sections of the exhaust which will get in your way for the installation. This includes the driver's side loop and the passenger's side crossover pipe. Now you will have room to work. Save the hardware for this will be reused and needs to be put back together.
 - c) Remove all of the OEM front upper and lower control arm mounts from the frame using a reciprocating saw, cutting wheel or plasma cutter for the welds. Clean the paint off the inside of the frame where the new long arm bracket touches frame.
 - d) Once most of the bracket is removed, use a worn-out flap disk to slowly smooth the frame until the bracket is no longer visible.



Driver's Side Front Frame Rail



Pass's Side Front Frame Rail

ROCK KRAWLER

S U S P E N S I O N

- 23) Grab your new front long arm brackets and cross member. Lower the OEM Skid Plate and slide the supplied RK Cross Member/Long Arm Mount Kicker Brace between the OEM skid plate and the bottom of the cross member. Re-install the four bolts you previously removed. Then bolt the front mounts to the plate using supplied ½” carriage bolts, ½” lock washers, and ½” jam nuts.
- 24) Use a center punch to mark the upper hole for the weld nut. X2 will require this only on the passenger side and Adventure X2 will require it on both sides.
 - a) Remove the long arm mounts and drill the hole using a 1.5” hole saw or step bit that goes up to 1.5.” Or plasma cutter if you like.
 - b) Reinstall the long arm mounts and prepare to weld the mounts in.
- 25) Weld the new heavy-duty frame side mounts on the inner frame. Be sure to push the long arm mounts tightly against the frame prior to welding. See the welding schedule below for the new long arm brackets. Use a 3/16” fillet weld along the portions highlighted in the drawing. Weld continuously along the bracket according to the image below. Welding the top is **optional** – the bracket will have enough structural integrity without it. If you choose to weld, it will require lifting the body from the frame.

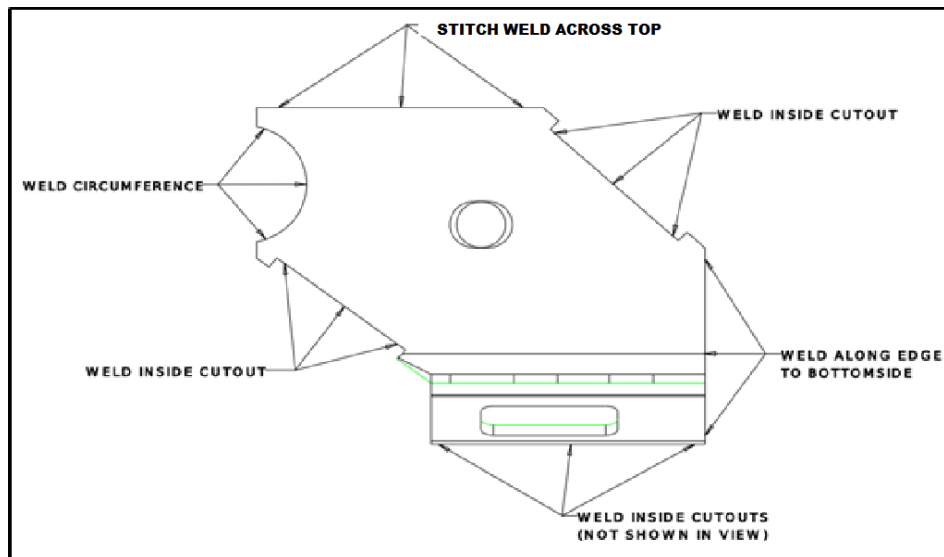

Note: The X2 series drivers side bracket looks slightly different than shown. There is no upper arm connection on the driver's side for X2 Kits.

ROCK KRAWLER

S U S P E N S I O N

- 26) After your brackets have been installed, apply a durable finish to the frame and bracket. Allow it to dry before moving on.
- 27) Clean your brackets with rubbing alcohol and use the supplied heat shield/ sticky shield material to cover the bracket walls that will be closest to the exhaust. We do this to protect the joints from overheating. Place the heat shield on all exterior walls close to the joint. Model your heat taping from the pictures below.



Pass. Side Heat Shield



Driver Side Heat Shield (Adv. X2 Shown)

- 28) Reinstall Tie in plate using supplied carriage bolts.
- 29) Install front upper control arm(s) with supplied 14mm x 100mm hardware into frame bracket and axle (X2). Ensure the bends are oriented away from the exhaust and frame. Adventure X2 attaches to the axle using the OEM hardware.

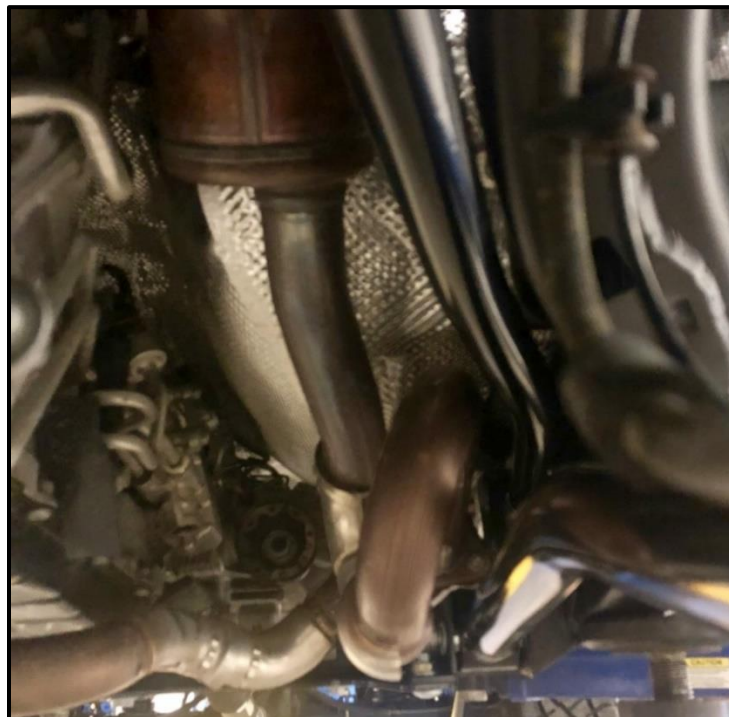

Driver Side Adventure X2 Upper Shown

ROCK KRAWLER

S U S P E N S I O N

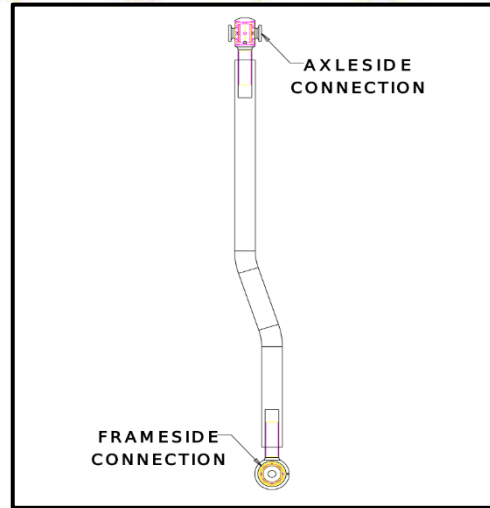
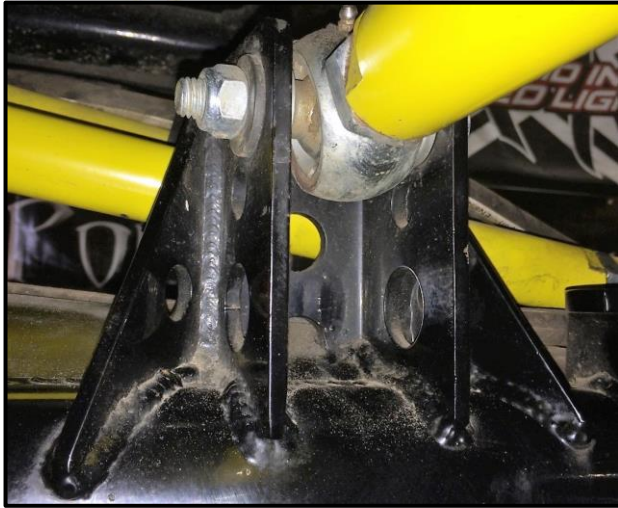

X Factor X2 Axle side

X Factor X2 Passenger Upper

- 30) Install lower control arms with supplied 5/8" x 4.5" bolt, 5/8" lock nut and a 5/8" washer on each side. The bend in the arm goes up for better ground clearance.
 - a) On X2 the welded end of the arm goes to the frame and the Krawler joint needs to have the zerk pointed up to protect from rocks.
 - b) On Adv X2 the welded end goes to the axle and the adjustable end goes to the frame.
- 31) Reinstall exhaust. Customization might be required.
- 32) Install the supplied front coil springs. Rotate the coil until the end winding seats into the rubber isolator pocket on top. If the coil is not seated properly it can possibly bow excessively. A critical detail is making sure the top OEM spring isolator is seated correctly with both rubber nipples sticking up through the holes in the OEM mount. As listed above, Rock Krawler's lower spring seats on the axle and factory upper in coil bucket. If coil bows front to back check caster if it bows side to side check track bar. If still bowing in towards the frame, then Rock Krawler neutral upper isolators might be needed and is year and model dependent. (**RK08244K**)
- 33) Install the front shocks using OEM hardware for the upper location. Reusing the shorter bolts from the OEM rear sway bar links for the lower shock mount instead of the OEM lower shock bolts is a better fit for this application and will ensure the bolt does not contact the high clearance bend portion of the control arm.
 - a) If you purchased the **RRD 2.25 shocks**, you would notice that the front shocks have offset ends, both top and bottom, this should be installed to push the shock body away from the frame, to avoid interference between the frame and shock. You might need to swap the bushing and sleeve insert with the one supplied with RRD shock if shock came assembled differently. The Schrader valve should be installed so that it is pointing towards the rear of the Jeep. Please note: RRD 2.25 shocks require recharging at certain intervals. They need to be 50 PSI at full extension. They may need to be removed from the vehicle to charge properly. Nitrogen performs the best; compressed air is forbidden.
 - b) **Coil over kits:** Follow the instructions at the end of these instructions.

ROCK KRAWLER

S U S P E N S I O N

34) As you are compressing the suspension, install the front track bar with the OEM hardware. Be sure to set it to the starting dimensions for your system as specified above. The rebuildable Anti-Wobble Joint (Welded End) goes to the frame connection with the zerk facing down and the anti-wobble (Buna -318) O rings, on each side. The heim joint (non-greaseable joint) with the supplied high misalignment spacers go to the axle connection.



Frame side track bar



Axle side track bar

35) Reattach the drag link to the passenger side knuckle.

36) Choose your front sway bar link package: Either Gen 2 Disconnects or No Limits Links (Rubicon Models). Gen2 Disconnects follow steps A through F. For No Limits Links follow step G and H.

****Please note 2024 Requires special adapters for the up sized hardware.****

- a) For **Gen 2** Sway Bar Disconnects.
- b) For the **Driver** and **Passenger Side Top**: The Offset Spacer with the Disconnect Pin goes against the sway bar and is secured with a 1/2" washer and 1/2" nylok nut. Orient the Disconnect Pin so the lynch pin goes in vertically.
- c) For the **Driver** side **Lower**: The bottom disconnect pin gets secured to the outside of stock sway bar link mounting tab with a 1/2" washer and 1/2" Nylok Nut. The bottom can be oriented in any direction you find easiest to remove the lynch pin.
- d) For the **Passenger** side **Lower**: Starting from the inside of the track bar mount. Tighten into the coupling nut the 1/2" bolt with 1/2" washer by holding the coupling nut and tightening the bolt. You may elect to use locktite at this time.

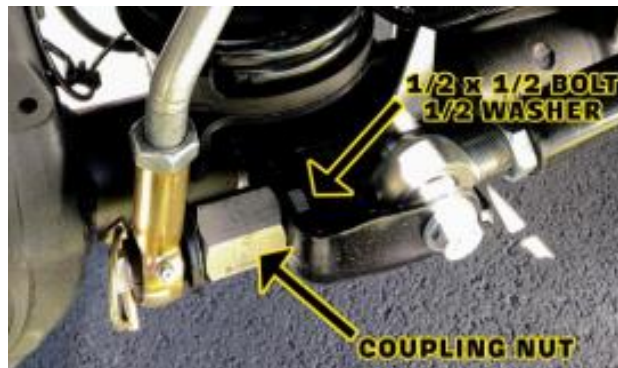

e) Slide the sway bar links on the disconnect pins top and bottom and insert lynch pins.

Helpful Hint: lubricate the pins with WD40 or Liquid Fluid Film to make them easier to slide on and off the stainless steel disconnect pins.

ROCK KRAWLER

S U S P E N S I O N

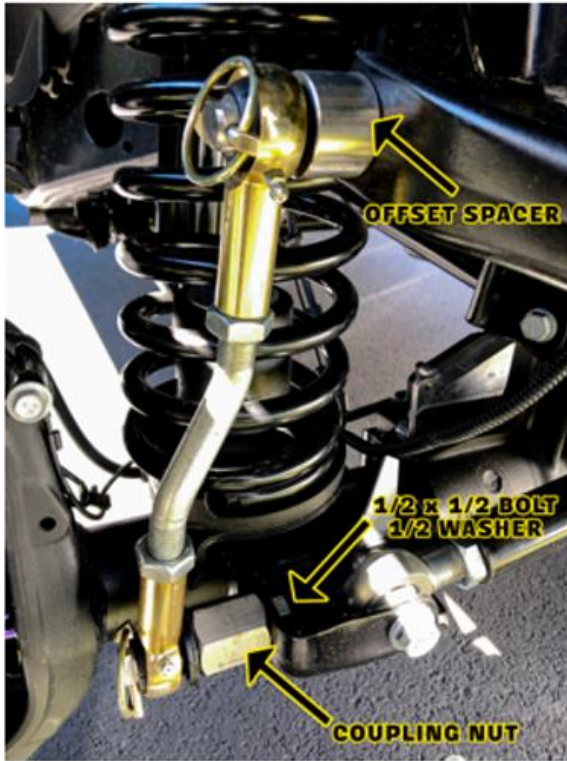

Passenger Side

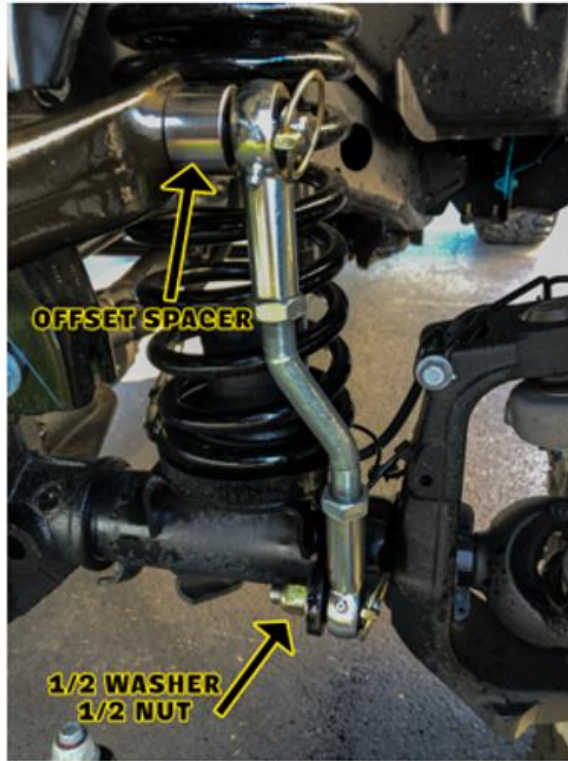

Driver Side

Please Note: When locking the jam nuts, the offset in the sway bar link pin is to the outside of the vehicle. Some aftermarket axle housings may not line up exactly like the OEM housings so you can rotate the center link to a front and back offset on those housings as needed.

Please note: An extra 1/2 washer and nylok nut is included for the passenger side lower mount for aftermarket axle housings that will not support the coupling nut like the OEM housings do.

- f) To install your sway bar link straps, use the supplied 5/16" Bolt, Washers, and Nut to attach them as shown to the coil spring bucket. Or you can drill a hole in a more preferred place of your liking.



ROCK KRAWLER

S U S P E N S I O N

- g) For No Limits Links: Set your sway bar links to the lengths based on lift height. Torque the jam nuts to 60-75 ft-lbs. with the joints in line with one another. This can be done in the vehicle.
- h) Use the supplied 12mm x 70mm bolts, four washers and locknut for each side. Refer to the images above for the orientation of hardware. One washer connects the head of the bolt, that bolt goes through the sway bar link and through the sway bar hole. Then attach another washer followed by a locknut. Torque the two 12mm bolts to a value of 75-80 ft-lbs.



Passenger's side connection shown

- 37) If disconnected, reinstall the front driveshaft in the same position it was originally for balance.
- 38) Install wheels and tires and lower vehicle to the ground. Tighten any remaining connections required.

REAR OF VEHICLE (Perform all Steps for the System You Are Installing)

- 1) Make sure the vehicle is on a level, hardworking surface if you are using a floor jack and jack stands.
- 2) Block the front wheels so the vehicle cannot move.
- 3) Raise the rear of vehicle and support with safety jack stands. Locate jack stands on the frame behind the rear axle.
- 4) If you are using a vehicle lift, place the lift arms according to those specific vehicles lifting procedures. Ensure that the lift arms will not interfere with the components that are being replaced.
- 5) Remove the rear wheels and tires with axle supported by a floor jack.
- 6) Remove the rear shocks and sway bar links and discard.
- 7) Do not overextend the drive shaft. Disconnect the rear driveshaft from axle and mark holes to reassemble in the same orientation if needed. Secure out of the way.

ROCK KRAWLER

S U S P E N S I O N

- 8) Add slack to the breather hose and lower the rear axle assembly onto the jack stands to unseat coils.
- 9) Remove the rear coil springs and spring seats and discard. Save OEM upper isolators for reuse.
Note: Retain one OEM upper seat if you have a **392**.
- 10) Remove the rear track bar and discard, save the OEM hardware for reuse.
- 11) Remove the rear lower control arms, save the OEM hardware for reuse. Discard arms.
- 12) Remove the rear upper control arms, save the Axle hardware. Discard arms and frame hardware.
- 13) **For Rubicon models only;** remove the electric locker line from the plastic clips holding it to the cross member as shown below to gain slack in the line. **(Shown Below)**



- 14) Disconnect the E Brake Cables from the axle and reroute them ahead of the upper cross member instead of behind the cross member to gain the necessary slack in the E Brake Cables and reattach them to the axle as shown below. Be sure to remove and discard the clip that holds the E brake Cables to the bottom of the floor. **(Shown below)**



ROCK KRAWLER

S U S P E N S I O N

- 15) Remove all of the OEM rear upper and lower control arm mounts from the frame. Smooth the frame with a flap wheel disk. Trim the rear most body mount on each side of the frame as shown to allow for clearance for the high clearance lower control arms.



Trimmed Body mount

ROCK KRAWLER

S U S P E N S I O N

16) Using a Uni-bit that steps up to 1" in diameter, upsize the hole in the frame as shown below so the newly supplied rear lower control arm mount welded nut allows the mount to sit flush on the frame.



17) Align the new control arm bracket to your frame and use C-clamps to hold it in position. Tack the bracket in place once in position. Similarly, to the front brackets, weld inside the designated cutouts on the bracket. It is important to weld the plug weld area, which is the vertical slot in the bracket. Driver Side Shown Below. Make sure the mount sits flush to the frame on the side and bottom with the nut recessed.



ROCK KRAWLER

S U S P E N S I O N

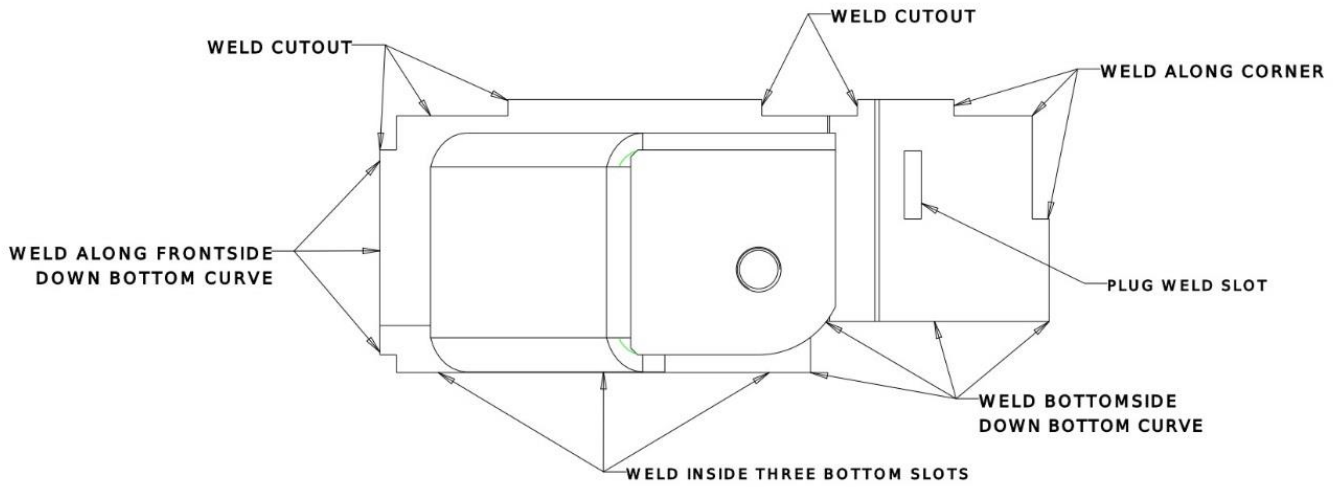

18) Remove the outside of the OEM shock mounts down to the flat face as shown below. The new mounts will mount over the top for placement and structure.



ROCK KRAWLER

S U S P E N S I O N

- 19) Fold over two areas of the pinch weld seam on the passenger side gently for the mount to fit flush as shown below. On the driver's side you will want to redrill the hole in the fill tube mount and bolt it back to the OEM bolt so it is pulled away from the new shock bracket.

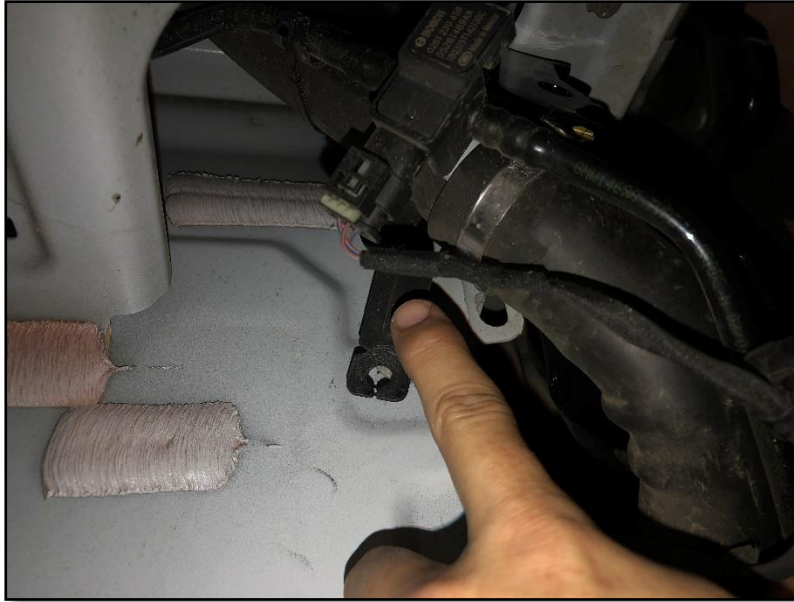

- 20) Prior to welding on the new raised shock mounts, apply a durable finish to the face of the old back surface of the OEM shock mount to minimize rust and or corrosion.
- 21) Grab the mounts, loosely bolt them to the OEM shock mount with the supplied 12mm x 30mm bolt and washer as shown. Prepping the surfaces, weld the new raised rear shock mounts where they contact the frame. Tighten Hardware after tacking bottom legs. Paint with a durable finish once cooled. **Please note:** There is a specific driver side and passenger side mount. A good helpful hint is when the mounts are fastened in place on the proper side, the rear leg of the mount will be almost vertical.

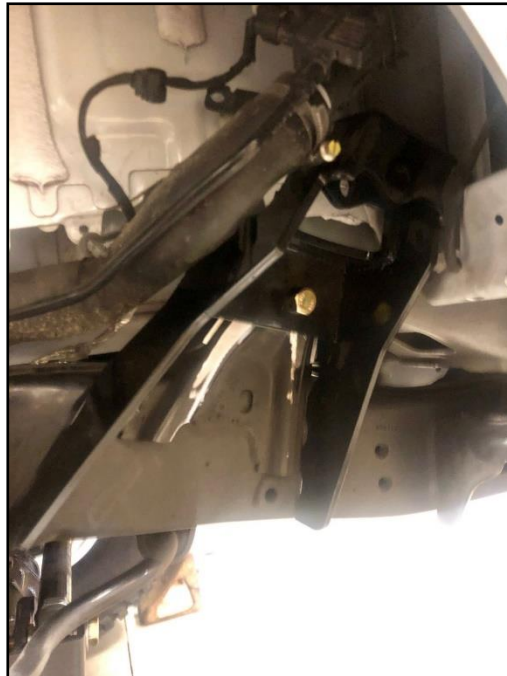

Driver Side Shown

ROCK KRAWLER

S U S P E N S I O N

22) Prepare to install the rear upper control arm mount onto the frame.

- a) Prep the surfaces for welding the third link mount to the OEM cross members by removing the OEM finish as shown below.



Forward Cross Member



Rear Most Cross Member Ahead of the Axle

- b) Align the hole in the forward cross member with the hole in the third link mount. Make sure the mount is going straight back and weld it in place on all contacting surfaces on both the front and rear cross members. Allow it to cool and apply durable finish.



ROCK KRAWLER

S U S P E N S I O N

- 23) Prepare to remove rear track bar bracket. First, mark your rear track bar bracket mounting hole location side to side. This will be an important step to line up the new track bar bracket when it gets welded to the axle housing.
- 24) Remove the axle brackets for rear upper and lower control arms, track bar and shocks.
- 25) Weld the supplied new rear track bar bracket to the axle housing by lining up the marked bolt hole location from the stock mount with the hole in the bracket, then orient the back surface of the new track bar bracket so it is parallel to the diff. cover and new rear cradle.
- 26) Install the cradle onto the rear axle. Center the cradle left to right on the axle and make sure the third link mount on the top is open to the front. Then hold the offset tool as shown below against the factory differential cover and rotate the cradle back until it contacts the offset tool. Remove any paint where the cradle touches the axle for a good weld. Weld it in place on front and back using a 1/4" fillet weld as shown below. Apply a durable finish of your choice after welding.

Please note: If you have a thick aftermarket diff cover or something other than stock, be sure to compensate for the difference in thickness. The OEM diff covers are approximately .150-.188 (3/16) thick for reference.

Please Note: Our rear cradle and axle brackets are designed around OEM axles. If you have another axle contact us for proper brackets.

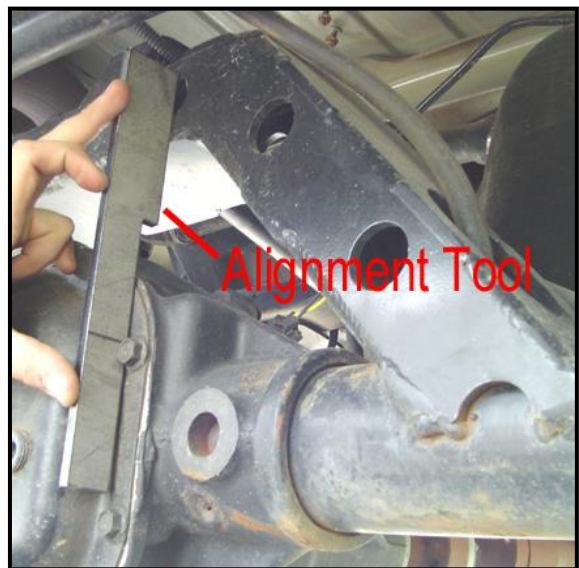
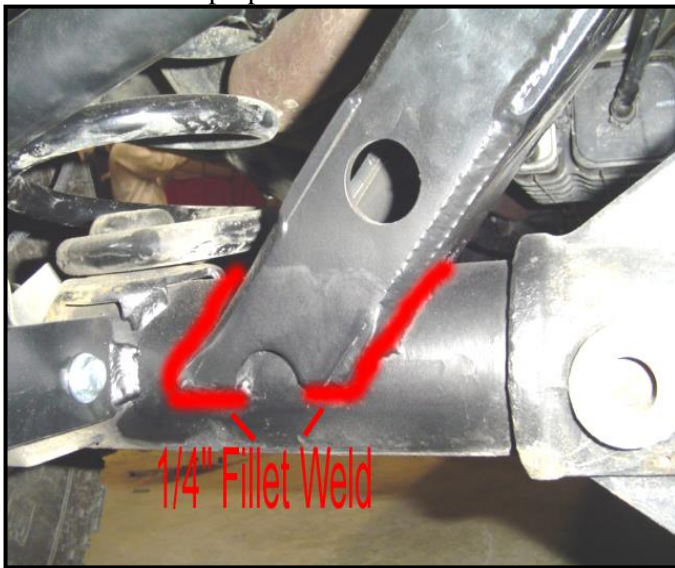

- 27) Weld on the brake line mounting brackets supplied with the kit, one to each side. The pass. side is shown on next page. The bracket is just off the weld for the outer bearing hub and the back surface is parallel to the rear diff. cover, rear cradle, and rear track bar bracket.



ROCK KRAWLER

S U S P E N S I O N

28) Weld the new high clearance lower control arm mounts. There is a specific driver side and pass. side. The mounts will have a hole on the inside of each mount and the shock mounts are offset to the outside of the mount as is the sway bar link attachment point. We will cover the driver's side (The pass. side is the mirror of the driver side).

On all axles except 392 or XR axles with raised bump stop seat: Using the alignment tool, bolt it to the top of the bump stop pad and to the side of the inside of the lower control arm mount. Make sure the new bracket is tight to the tube, then tighten the hardware and fully weld the mount in place all the way around the mount both front and back where it contacts the axle tube. Perform the same operation on the passenger side with the passenger side mount.

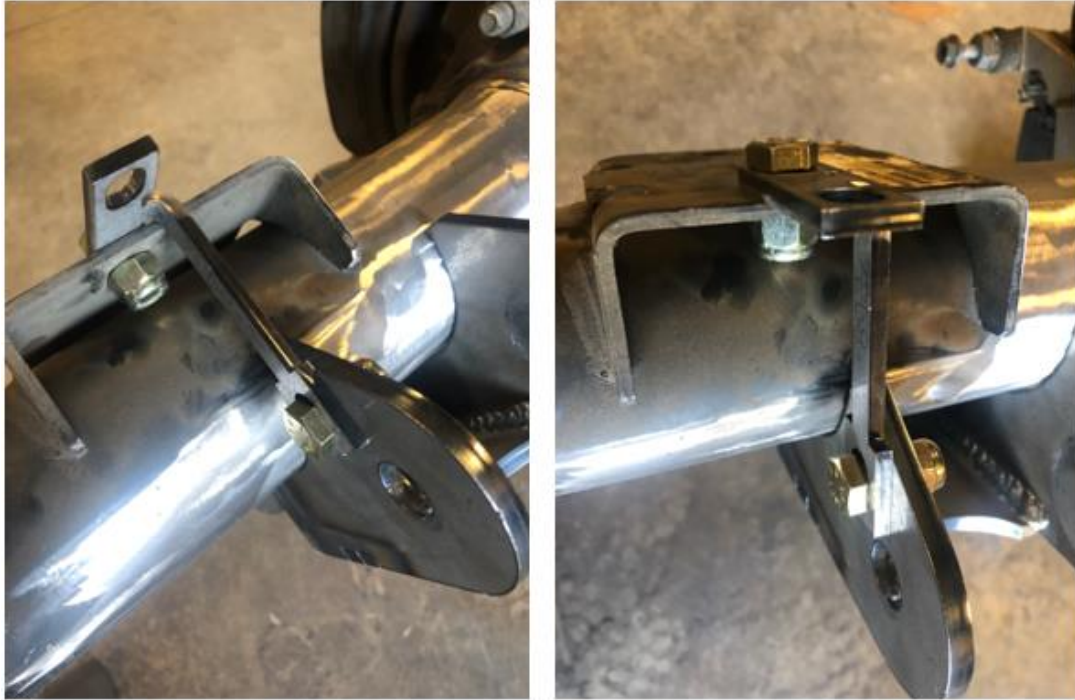

Driver Side Shown In Both Views Above For Reference

If installing on a 392 or XR package on stock axle with taller bump stops: The rear alignment tool needs to be spaced down accordingly to account for the rear bump stop pad height of 1.125" for everything to setup correctly.

Complete Rear Axle Assembly for Reference



ROCK KRAWLER

S U S P E N S I O N

- 29) Install the rear upper control arm. Set the arm to the length specified on page 5 of the instructions. This is a double adjustable arm with a bend in it. The bend goes down. The long leg of the arm goes to the front of the vehicle. We suggest starting in the middle hole at the axle connection. To increase Anti-Squat move it to the top hole. To decrease the anti-squat move it to the bottom hole.
- a) **For X2:** Alongside the joint housing for the frame connection are anti-wobble bushings. Make sure there is one on each side of the joint housing. Attach the arm using the supplied 14mm x 100mm bolt, washers and nylok nut.
- 30) Install the rear lower control arms. Set your lower arms to the lengths specified on page 5 of the instructions. **Please note:** the bend in the arm goes up. It is a high clearance lower control arm, not a low clearance arm.
- a) **For X2:** Attach the Adventure Joint (Welded End) to the new frame mount using the supplied 5/8 x 4.5" Bolt and Washer. Attach the Krawler Joint (Adjustable End) to the new X2 mount on the axle using the supplied 5/8 x 4.5" Bolt, Washers, and Nylok Nut. Orient the Zerk up to protect it.
- b) **For Adventure X2:** Attach the Adjustable Adventure Joint to the new frame mount using the supplied 5/8 x 4.5" Bolt and Washer. Attach the Welded Adventure Joint to the new X2 mount on the axle using the supplied 5/8 x 4.5" Bolt, Washers, and Nylok Nut.
- 31) Prepare to install the spring seat(s) on the axle. They go directly onto the axle tube. Remove any additional coil puck or spacers. The thickest part of the spring seat goes toward the rear of the vehicle. There is a locator nub in the rear of the wedge for proper orientation. There is a specific driver and passenger side depending on the vehicle drivetrain- listed below.
- The coil correction wedges will be marked by a 1 or D or RK06703 and 2 or P or RK06704 on the bottom of the spring seats. The RK06703 is .445" thick in the front and .625" in the back. The RK06704 is .815" thick in the front and .995" in the back. Pictures on following page
 - **3.6L and 2.0 Turbo and Diesel** uses a thick on the passenger and thin on driver side.
 - **392 Models** use only a Thick Spring Seat on the passenger side rear. The Driver Side just uses the OEM spring seat
 - **Please note that the markings are for LHD applications. RHD is reversed**



Driver Side Spring Seat



Pass. Side Spring Seat w/ Spring Installed

ROCK KRAWLER

S U S P E N S I O N

- 32) Install the Rock Krawler rear coil springs. Make sure to put the closer wound coils go up and the end coil winding is sitting in the top spring seat properly. **Please note:** The top spring seats are indexed as well with a pin to set their orientation. This too must be correct.
- 33) Set your rear trackbar to length and install with the bends oriented away from the differential cover. Do not lose the two rubber O-rings (anti-wobble isolators) at the frame end. Grease the inside of the frame side bracket so the rings do not rip. The rebuildable Anti-Wobble Joint (Welded End) goes to the frame connection with the zerk facing down and the anti-wobble (Buna -318) O rings, on each side. The 7/8" shank heim joint (non-greaseable joint) with the supplied high misalignment spacers go to the axle connection.
- 34) Install the rear shocks using the OEM hardware at the axle and supplied 12mm x 80mm bolts, washers, and nylok nuts at the frame connection. **Please note:** To fit the shocks in the rear upper relocated shock mounts a bushing and sleeve conversion will need to be done from the OEM style bushing and sleeve at the frame connection to the OEM style at the axle connection for the frame connection.
- 35) If purchased, install the RK fabbed rear bump stops. Our rear fabricated bump stops mount to the factory bump stop pad using the supplied 3/8 x 3/4 bolts, washers, and nylok nuts. Make sure the bumps stop angles to the front of the vehicle as shown in the photo below. After the full installation is complete cycle the suspension to ensure the bump stops are making contact correctly. If you elect to add additional bump stop pucks to the pre fabbed pad, we recommend having the rubber bump puck installed as far forward as possible of the pad to start.
- a) For 3.5" lifts we recommend **one** additional 1" rubber pads stacked on top of the mounting pad.
 - b) For 4.5" lifts we recommend **two** additional 1" Rubber pads stacked on top of the mounting pad.



ROCK KRAWLER

S U S P E N S I O N

36) Install the Supplied Pro Rear Sway Bar Links. **Please Note:** The Extra Thick Washer goes on the outside of the ball end so the housings and link assembly cannot slide off. Think of it as an extra-large retaining washer.

- a) The *pro link top* connection uses the supplied 12mm x 50 mm bolt, washers and nylok nut as shown below. Under the head of the bolt, there is a small washer and on each side of the sway bar link ball joint there is a washer and finally they are secured with the nylok nut. The large washer goes against the ball to retain the ball and socket joint.
- b) The *pro link bottom* connection uses the supplied 12mm x 50 mm bolt, washers and nylok nut as shown below. Under the head of the bolt, there is a small washer. Between the sway bar link ball joint and the OEM mounting bracket, there are two washers to provide extra clearance between the housing and the billet link end, then there is one more washer on the other side of the joint, then finally secured by the nylok nut.

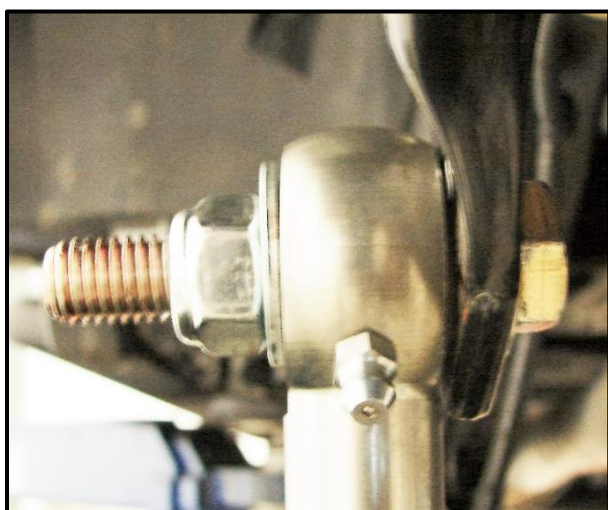

<Top
Bottom>

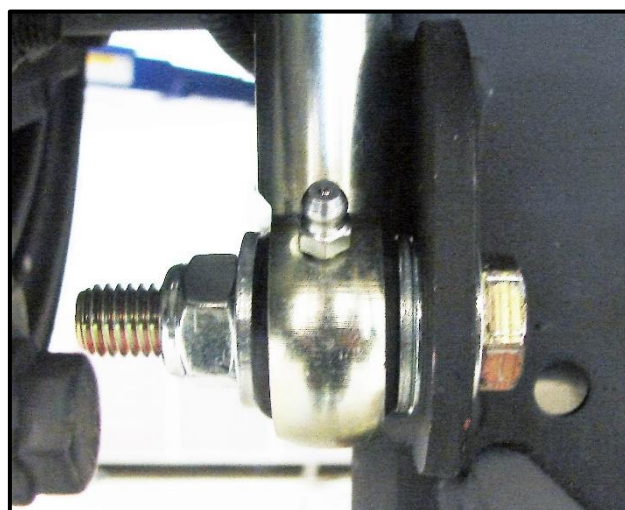

Recommended Starting Lengths

3.5" Systems – 12.5" / 4.5" Systems – 13.0"

37) If disconnected, reinstall the front driveshaft in the same position it was originally for balance.

38) Install the rear wheels and tires and lower the vehicle to the ground and tighten all mounting bolts.



Congratulations, you have just finished installing your Rock Krawler Suspension System! Your Jeep is now free to roam about the country.

Before hitting the pavement or the trails be sure to make sure the control arms are oriented properly, all spherical joints (Heim joints and Krawler Joints) are oriented correctly to allow for maximum movement without bind, and all jam nuts have Loctite on them and are tight. Make sure all Adventure joints are relaxed and neutral at ride height. Make sure the axles are properly centered, pinion angles are correct, there is proper slack in ABS lines, and all lines are properly routed. Go back over all your hardware and make sure each connection is tightened to its proper torque spec. Check your vehicles articulation and ensure that no moving parts contact or interfere with any other components throughout the travel (brake lines, shocks, coils, sway bar links). Also check to see if at full flex your coil spring loses tension, if so you may want to look into a limit straps. You may need to look at bump stops depending on what shocks you choose to run.

A note about tires, wheels, tire pressure and how it effects ride quality:

Tire and Wheel combinations at a given tire pressure have their own spring and dampening rates associated with them. This plays a major part in ride quality and off-road performance. The stock tire pressure settings on your Wrangler are based on stock C rated light duty tires on 17" wheels. Larger aftermarket tires typically have a much firmer side wall than the stock ones, thus increasing the spring rate and decreasing the dampening rate associated with the tires themselves. Going from a C to a D or E rated tire also amplifies this effect. Increasing wheel diameters cuts down on the sidewall size of the tire; for example, going from a 17" wheel to a 20" to 22" wheels will increase the spring rate and decrease the dampening rate of the tire and wheel combination. As you increase tire strength and wheel size it is common to have to reduce the tire pressures in order to make your aftermarket tire and wheel combination feel like a stock wheel and wheel combination.

Choose pressures wisely and safely! This is one part of your suspension tuning you can do on your own.

ROCK KRAWLER

S U S P E N S I O N

Recommended Alignment Specs are as follows;

3.5" Lift Height: 5.0 to 6.0 degrees of Caster with a .2 to .4 Cross Caster Split (.2 to .4 degrees more caster on the pass. side than the driver's side. This is to account for road crown.)

4.5" Lift Height: 5.0 to 6.0 degrees of Caster with a .2 to .4 Cross Caster Split (.2 to .4 degrees more caster on the pass. side than the driver's side. This is to account for road crown.)

Tow: Factory specifications



The rear pinion angle should be down 2 – 3 degrees from the driveshaft as shown above.



Common Service Parts Listings:

Front and Rear Lower Control Arms

AX2 (4 Link) Front and Rear Control Arm Adventure Series Joint (Frame End) – RK08193

AX2 (4 Link) Front and Rear Control Arm Adventure Series Joint Center (Axle End) – RK07404K

X2 (3 Link) Front and Rear Lower Control Arm Adventure Joint Center (Frame End) – RK07404K

X2 (3 Link) Front and Rear Lower Control Arm Full Replacement Krawler Joint (Axle End) – RK05067

Lower Control Arm Krawler Joint Rebuild Bushings – RK04034K – Requires Large Joint Tool – RK04484

Front and Rear Track Bars (RK06187HD and RK06692B)

Front Track Bar Replacement Heim Joint (Axle End) – RK07535 (1" Shank)

Misalignment Spacers – RK03428

Anti-Wobble Joint Bushings (Frame End) – RK07836K – Requires Small Joint Tool – RK04487

Anti-Wobble O-rings (Buna -318) - RK05181

Rear Track Bar Replacement Heim Joint (Axle End) – RK03426 (7/8" Shank)

Misalignment Spacers – RK03428

Anti-Wobble O-rings (Buna -318) - RK05181

Front Upper Control Arm(s):

AX2 (4 Link) Front Upper Arm – Full Joint – RK07427

AX2 (4 Link) Front Upper Arm – Joint Center - RK07409K

X2 (3 Link) Replacement Krawler Joint – RK04153

X2 (3 Link) Replacement Krawler Joint Bushings - RK04034K – Requires Large Joint Tool – RK04484

Rear Upper Control Arms:

AX2 Replacement Adventure Series Joint – RK07427

AX2 Replacement Adventure Series Joint Center – RK07409K

X2 Replacement Krawler Joints – RK04153

X2 Replacement Krawler Joint Bushings – RK04034K – Requires Large Joint Tool – RK04484

Sway Bar End Links:

Ball Center – RK04573

ROCK KRAWLER

S U S P E N S I O N

Front Coil Over Installation

Please Note: This must be done with the coil spring removed.

- 1) Remove inner fenders on each side. Also remove the main battery and plan to relocate the AUX battery if needed. Some models require Vacuum pump relocation also.
- 2) Remove the stock shock brackets from your Jeep. It is easiest to score the weld marks and cut the OEM shock tower into pieces. Be sure not to cut any important hoses or wires behind the shock tower. Re-paint any exposed areas with a durable coating after the towers have been removed.



Passengers Side Bracket Removed

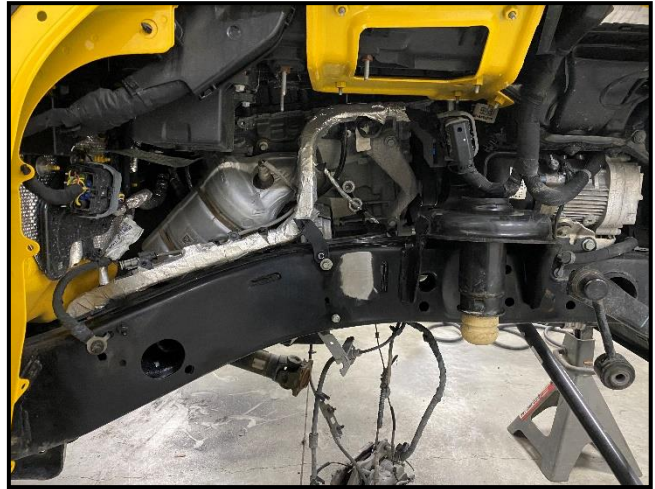

Drivers Side Bracket Removed

- 3) Make sure to bend the driver's side bracket upwards before test fitting your coil over towers. This will stop the new towers from hitting.

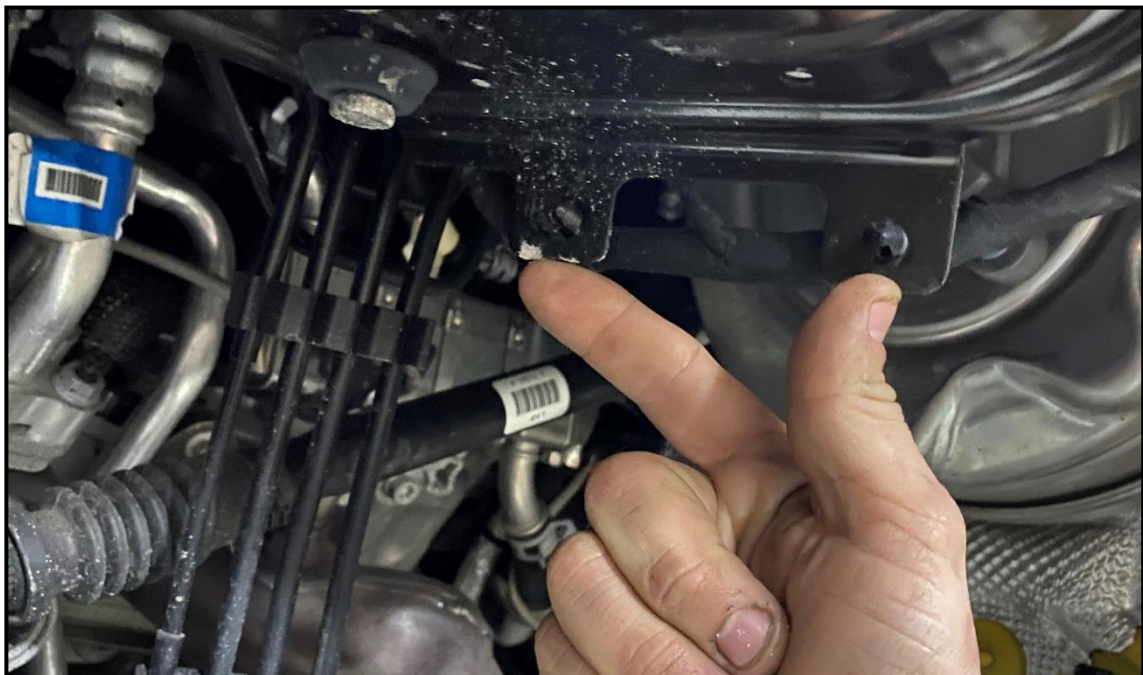

ROCK KRAWLER

S U S P E N S I O N

- 4) Test-fit your coil over brackets as shown below. Clamp the mount about the oval frame side hole and center punch one of the 1/2" holes. Remove the tower and drill out one 1/2" hole on the side of the frame. After that, center the coil over mount on the spring tower and drill three 7/16" holes in the spring tower.



- 5) Bolt the tower down. The two frame connections get 1/2" x 1.25" bolts, two washers and a locknut each. The three spring tower connections get 7/16" screws, two washers and one locknut each.
- 6) Next, remove the OEM bottom shock mount from the frame. You may need to use a Dremel in order to get the last of the mount off the axle cleanly.
- 7) Set the caster on the axle to 5 degrees as shown below before welding on the new lower coil over mounts. Keep the axle at that angle for the proceeding steps. Measure from the top ball joint surface.



ROCK KRAWLER

S U S P E N S I O N

- 8) Grind the powder coat off the new mounts in all applicable weld surfaces. Measure $\frac{3}{4}$ " away from the inner C for Rubicon models as shown below. For Non-Rubi models, bring the new mount as close to the axle C as possible. This is because JL Rubi Axle WMS is 68.00"/ JL Sport/Sahara WMS is 66.50." For 73" WMS Dynatrac 60's measure 1" away from the inner C.

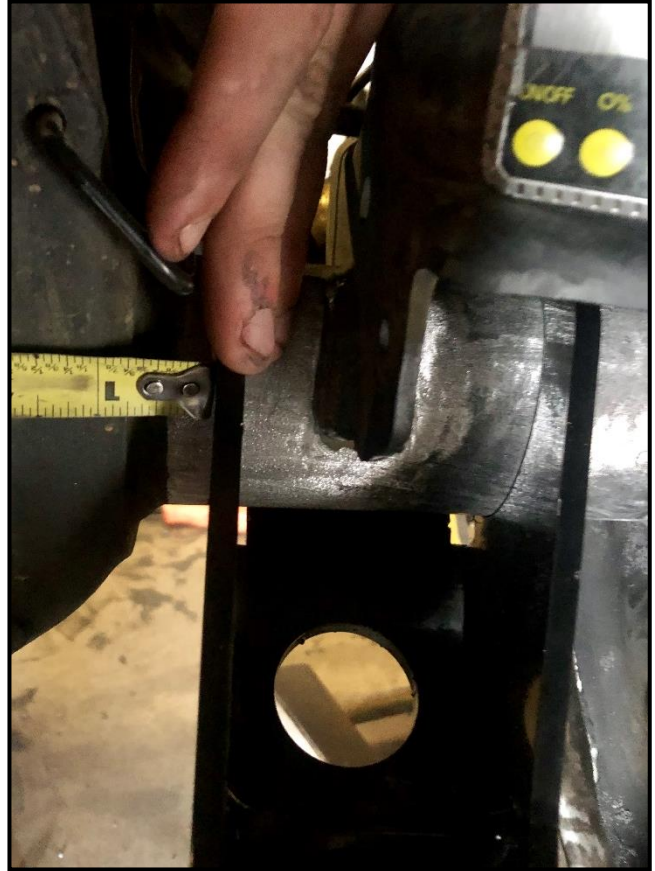

Please Note: For some axle housings you may have to trim the OEM spring bucket at the axle for proper coil over shock clearance.

- 9) While the axle caster is set to 5 Degrees, set the top surface of the lower coil over mounts to 0 Degrees. Make sure the outward spacing from the "C" and angle of zero are correct before you weld these mounts. After, apply a durable finish of your choice to the bracket to prevent corrosion.

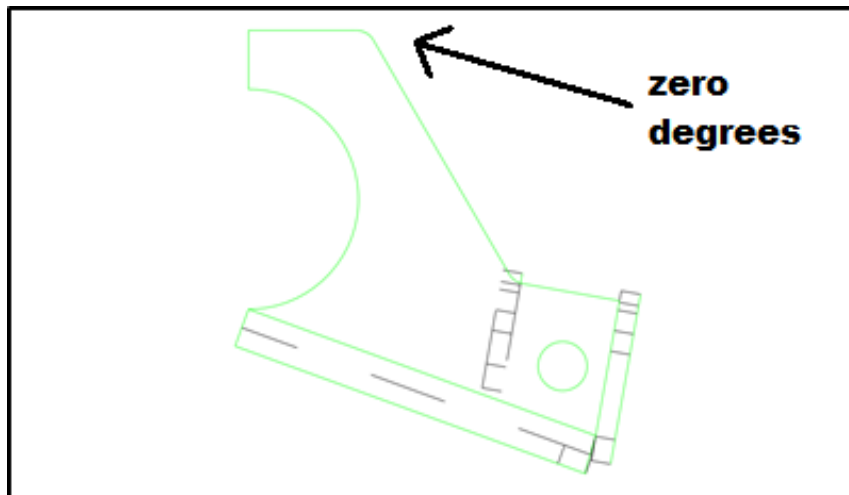

ROCK KRAWLER

S U S P E N S I O N

10) Test fit the coil over into the vehicle and confirm clearance and fitment.

- 11) Install coil over with minimal preload and transition rings in a spot where the slider will not contact. Place the supplied spacer on the top coil over connection on the inside of the bearing. Then secure the top connection with a $\frac{1}{2}$ " x 3.25" bolt with a washer on each side and locknut on the backside. Then place the $\frac{1}{2}$ " x 2.75" bolt through the bottom connection with a washer on each side, locknut on the back.
- *Please Note: These mounts are designed as large shock mounts as well as coilover mounts. The spacer simply makes this coilover compatible.

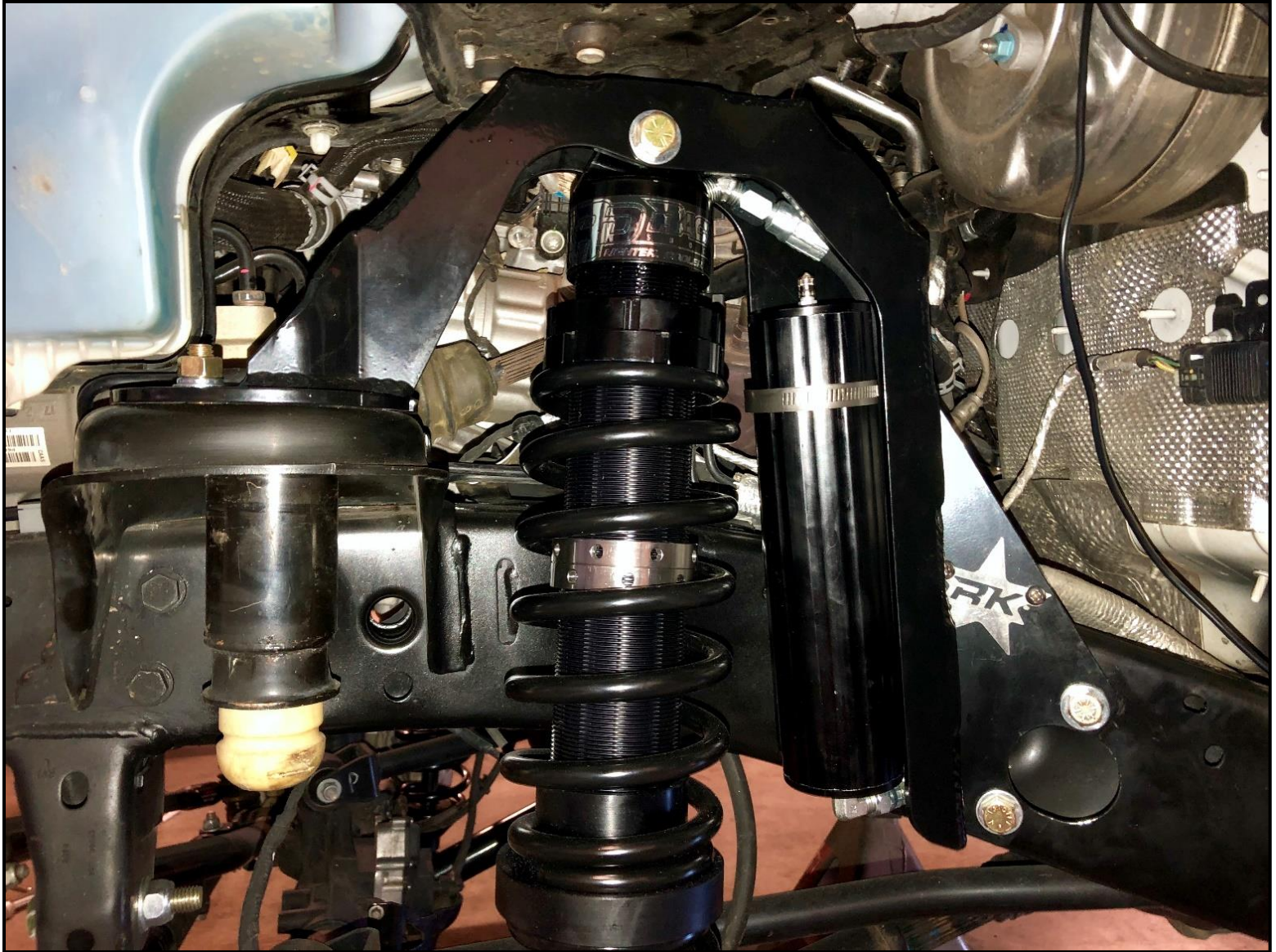

ROCK KRAWLER

S U S P E N S I O N

Rear Coil Over Installation

- 1) Grab the supplied Retsy mounting bracket as shown below. Mark the center point of the two holes and drill (2) 5/16 holes. Attach the reservoir mounting brackets with the (2) supplied 3/8 thread formers and (2) 3/8 washers as shown blow (Driver Side)

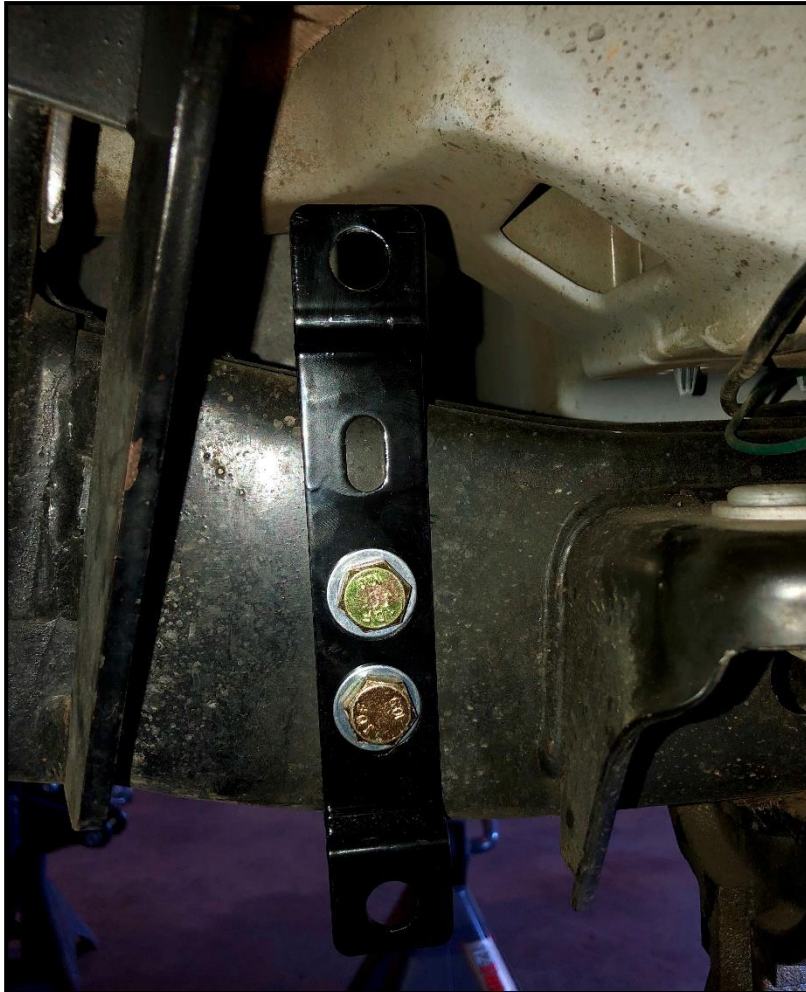

- 2) Install the Rear Coil Overs with the supplied 1/2 x 3.25" bolts, washers and nylock nuts as shown below. The Retsy attaches to the Retsy mount using the supplied stainless steel hose clamps. (Driver Side Shown). Please note: extra coil over coils are supplied in case you are running a full-size spare out back so change the top coil on the coil over assembly with the heavier one for a full-size spare prior to installation.

****Note: Just like the front upper mount for the front coil over assembly, the rear upper coil over assemblies have a high misalignment spacer that needs to be installed at the frame and axle mounts on the inside of the bearing. ****

ROCK KRAWLER

S U S P E N S I O N



Driver Side Rear Coil Over Shown



Coil Over Setup/Adjustments

Adjust the preload on the front and rear coil overs to achieve your desired stance. We recommend taking all the load off the coil overs to make adjusting the preload easy. Take your measurements while the vehicle was on the ground and adjust each corner as desired. Please note: each corner will more than likely be different as the Wrangler is not a perfectly symmetrical vehicle. Typically, you want to have 5" of up travel minimum at all 4 corners for a good ride and off-road fun. Set the crossover rings on the coil overs 1" off the plastic sliders for your initial transition starting point. This can be adjusted based on driving style and desires after the ride height is finalized. The closer the transition rings are to the slider, the faster the spring transition thus, you will not bottom out as fast. If you find you are not bottoming out ever, then move the transition rings away from the plastic slider. We recommend incremental movements of $\frac{1}{4}$ " from the initial starting position. **Please note: upon initial driving, the coil over coils will break in fairly quickly so it is common to have to make a few adjustments to preload and cross over rings until everything has been run in.*