

ROCK KRAWLER S U S P E N S I O N

INSTALLATION MANUAL

FOR

ROCK KRAWLER SUSPENSION, INC.

**JK/JKU ADVENTURE SERIES X2 LONG ARM and
X2 LONG ARMSERIES**

**2023 1st EDITION
8/1/23**



ROCK KRAWLER

S U S P E N S I O N

Dear customer: Thank you for purchasing the best system on the market for your Jeep Vehicle. We are sure you will be happy with this system after your installation is complete. Please take your time during the installation and be sure to do it correctly. Completely read the directions before starting your installation so you know what to expect. Remember, your personal safety depends on it. Should you have any questions during this installation feel free to give our tech line a call and we will be happy to help you. (518-270-9822)

Welcome to TEAM RK

Share your before & after pictures, install photos & wheeling images.

facebook



@RKSuspension

Instagram

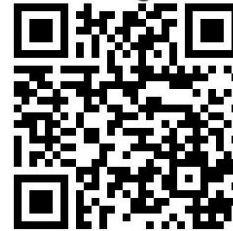

@rock_krawler

Note: BE SURE TO CHECK ALL FASTENERS FOR PROPER TORQUE BEFORE TEST DRIVE. RECHECK AFTER 500 MILES AND BE SURE TO CHECK PERIODICALLY.

WARNING

- Properly block and secure vehicle prior to installation.
- Always wear safety glasses when using power tools.
- Rock Krawler Suspension recommends the use of Loctite on all hardware, unless noted otherwise.
- The use of limiting straps is recommended to avoid damage from overextending the suspension of your vehicle.
- Read and understand all instructions, warnings and safety precautions in these instructions and your owner's manual before attempting to install these components.
- Proper installation of Rock Krawler Suspension products requires knowledge of recommended procedures for disassembly/assembly of OE vehicles and components. Access to OE shop manuals and special tools are required. Attempting to install this kit without knowledge of these procedures may affect the safety of your vehicle and or the performance of these components. Rock Krawler Suspension, Inc. strongly recommends that this system be installed by a certified mechanic with off-road experience.
- Rock Krawler Suspension does not recommend combined use of suspension lifts, body lifts or other lift devices. Combined use of lifts may result in unsafe and unexpected handling characteristics. Also, many states now have laws restricting Vehicle lift, bumper heights, and other alterations. Consult local laws to determine if your proposed alterations (including installation of this system) comply with your state laws.
- Rock Krawler Suspension does not condone or authorize the use of any other suspension components with its products. Should Rock Krawler Systems or components be installed in junction with other products or not per the provided instructions Rock Krawler Suspension warranty is void and is not to be held accountable for any resulting actions.

ROCK KRAWLER

S U S P E N S I O N

Driving and Handling Tips

- For Highway driving it is best to have the front sway bar connected. This will give you the on-highway ride and handling characteristics you expect. **If you choose otherwise, you do so at your own risk.**
- The ride quality and handling that Rock Krawler is known for is based on using OEM sway bars front and rear with approved shocks. Using any components other than directed can result in adverse handling characteristics and poor ride quality.
- For Off-Road use it is best to have the front sway bar disconnected and the rear sway bar connected. This will allow your suspension to do its intended function. Our suspension will give your vehicle unmatched articulation which will provide traction and feedback to keep your vehicle moving in almost all conditions. Let the suspension do the work! Even if you are a Rubicon Owner for most situations, we recommend manually disconnecting the front sway bar.

IMPORTANCE OF JAM NUTS

This is a note about jam nuts and the consumer's responsibility. The installer is the person or persons initially responsible for the proper setup of the suspension system and/or components and the initial tightening of the jam nuts. The jam nuts not only hold the orientation of the joint it is on, but it is the single component that puts the necessary pre-load on the joint's threads. The consumer or vehicle owner is the person or persons responsible for maintaining the jam nuts tightness. Failure to do so will result in the rapid deterioration of the threads in the control arm and will impose a "cause for concern" for the occupants of the vehicle. Failure to comply with the warnings heeded in the directions regarding the number of threads showing past the jam nut will also result in the same "cause for concern" for the occupants of the vehicle. All of the above items are the responsibility of the vehicle owner and or installer. If a threaded section of a component is bad it will show itself defective immediately. Threads that fail over time are due to improper maintenance of jam nuts and can be proven very easily. Thread sections and jam nuts not properly maintained or set up, are not covered under warranty. This is the end user and installer's responsibility.

ORIENTATION OF JOINTS

Orient the Joint for maximum amount of movement with the head of joint perpendicular to bolt / head of the joint vertical in the mounting bracket. This same rule for orientation needs to be followed for all heim joints. The photo below shows the right way (LEFT SIDE) and the wrong way (RIGHT SIDE) to orient a joint.

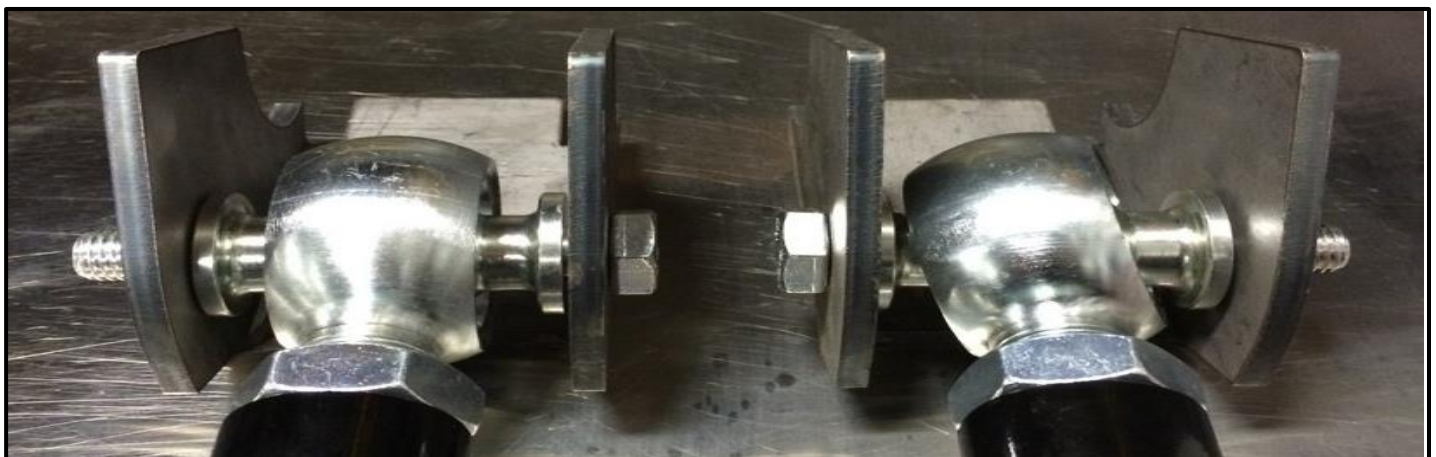

^RIGHT WAY^

^WRONG WAY^

ROCK KRAWLER S U S P E N S I O N

MAINTAINING JOINTS

Krawler Joints/Pro Flex Joints, Anti-Wobble Joints, and Pro Disconnect Joints

Before Jan 1, 2020, The Pro Series Krawler Joints, Pro Flex Joints, Anti-Wobble Joints and Pro Disconnect Joints are greaseable. They come pre-greased from the factory. The grease valley is machined into the housings. We require Triple Zero (000) grade grease for lubrication of all our joints. They will not take a lot of grease, nor do they need a lot of grease. Approximately every 4 to 6 months under normal operating conditions they should be greased. This is condition and use dependent so please use common sense. Over lubrication or using the incorrect grade of grease can do damage to the joints and hydraulically displace the race way material causing a sloppy joint condition. Never ever use red and tacky.

After Jan 1, 2020, The Pro Series Krawler Joints, Pro Flex Joints, Anti-Wobble Joints and Pro Disconnect Joints are greaseable. They come pre-lubed from the factory. The grease valley is machined into the housings. Grade 1 grease can be used in all joints. They will not take a lot of grease, nor do they need a lot of grease. Approximately every 4 to 6 months under normal operating conditions they should be greased. This is condition and use dependent so please use common sense. Over lubrication or using the incorrect grade of grease can do damage to the joints and hydraulically displace the race way material causing a sloppy joint condition. Never ever use red and tacky.

If the joint is not loose, it is not bad. Only if the ball is sloppy in the joint housing is it a bad joint and should be rebuilt. Krawler Joint Raceways, Pro Flex Joint Raceway, or Anti-Wobble Joint Raceways are available through Rock Krawler Suspension or an authorized dealer.

Please note: If you are not using the full range of motion of the Krawler Joint, Pro Flex Joint, or Anti-Wobble Joint very often, the lubrication will not be moving inside the joint. In such cases we recommend spraying down the outside of the Joint with WD-40 or Liquid Fluid Film to ensure the race ways do not dry up. In highly corrosive environments it is also recommended to spray down the suspension components with WD-40 or Liquid Fluid Film. This will minimize corrosion of the components due to exposure to the elements.

HEIM JOINTS (Non- rebuildable spherical joints)

All Rock Krawler Heim Joints use Teflon Liners and thus are self-lubricated. They too can also benefit from spraying down the outside of them liberally with WD-40 or Liquid Fluid Film. Grease should never be applied to them! Take caution when using cleaners and detergents on your vehicle as it can ruin the adhesives used on the Teflon liners yielding a bad heim joint!

Tools

An installation of this caliber requires the use of a broad range of general hand tools. Do not attempt this installation if you do not have a basic tool set and understand how to use them. Beyond your typical wrenches, socket, pry bars, hammers, etc. there are a few unique tools you may not realize will be helpful and you should gather before starting. Such as:

- Hole saw or Step bit up to 1.5 inch and angle drill
- Tin snips/ end nippers
- C Clamps
- Brake fluid
- Angle Grinder with cut off wheels, sanding disks and flap wheels. Plasma torch is helpful but not required
- Welder (required)
- Pickle fork (if removing Drag link)

ROCK KRAWLER S U S P E N S I O N

SUGGESTED STARTING LENGTHS

Measured from Bolt hole to Bolt hole in a straight line not along the bar

Front Track Bar

3.5" lift – 32 5/8"

4.5" lift w/ bracket – 32 7/16"

Front Lower Control Arms

3.5" lift heights – 34 1/8"

4.5" lift heights – 34 1/4"

Rear Lower Control Arms

3.5" lift heights – 30 3/4"

4.5" lift heights – 30 5/8"

Rear Lower Control Arms 6" Stretch 2 door

3.5" lift heights – 36 3/8"

4.5" lift heights – 36 7/16"

Front Sway bar links

3.5" lift heights – 12"

4.5" lift heights – 13"

Rear Track Bar

3.5" lift (w/ bracket) – 39 3/4"

4.5" lift (w/ bracket) – 40"

Front Upper Control Arms

3.5" lift heights – 35 3/4"

4.5" lift heights – 35 3/4"

Rear Upper Control Arms

3.5" lift heights – 26 3/4" (4 door)

4.5" lift heights – 26 7/8" (4 door)

3.5" lift heights – 27 1/4" (2 door)

4.5" lift heights – 27 3/8" (2 door)

Rear Upper Control Arms 6" Stretch 2 door

3.5" lift heights – 32 3/4"

4.5" lift heights – 32 13/16"

Rear Sway Bar links

3.5" lift heights – 12"

4.5" lift heights – 13"

****Please Note:*** All Control Arms, Track Bars, and Sway Bar Links come preassembled, but require adjustment to the above recommended starting dimensions. These measurements are taken from the center of one bolt hole to center of the other bolt hole. **Please check out our Rock Krawler YouTube Channel if necessary, for how to set the control arms properly and the importance of Jam Nuts...**





TORQUE VALUES FOR HARDWARE AND JAM NUTS

- All **10mm and 3/8 bolts** are torqued to **30-35 ft-lbs.**
- All **12mm and ½” bolts** are torqued to **75-80 ft-lbs.**
- All **14mm and 9/16” bolts** are torqued to **90-100 ft-lbs.**
- All **16mm and 5/8” bolts** are torqued to **120-140 ft-lbs.**
- All **7/8” Jam Nuts** are to be torqued **200-220 ft-lbs.** Up to 5/8” of threads showing past the jam nut is safe for final adjustment. These specifications are critical for the overall longevity of the threaded section.
- All **1” Jam Nuts** are to be torqued to **250-300 ft-lbs.** GET YOUR BIG BOY PANTS ON! Up to 3/4” of threads showing past the jam nut is safe for final adjustment. These specifications are critical for the overall longevity of the threaded section.
- All **1 1/4” Jam Nuts** are to be torqued to **275-325 ft-lbs.** GET YOUR BIG BOY PANTS ON! Up to 7/8” of threads showing past the jam nut is safe for final adjustment. These specifications are critical for the overall longevity of the threaded section.

THE USE OF ANTI SEIZE

If you are in a corrosive environment and would like to prevent rusting and or seizing joints, Rock Krawler recommends the installer removes all thread in joints before installation to apply anti-seize inside the threaded connections. This will make future adjustments much easier if needed years down the road.

THE USE OF LIQUID FLUID FILM OR WD-40

If you are in a corrosive environment and would like to protect the finish of the underside of your vehicle, suspension components etc., Rock Krawler recommends cleaning thoroughly a few times during the winter months and applying Liquid Fluid Film or WD-40 to the underside of your vehicle. This will help minimize corrosion due to Rock Salt, Liquid Salt, Mag. Chloride and combination with sand and salt.

Please note: You will also have to relocate the muffler from the rear under the trunk since the shock brackets will be moved up and back to allow for more ground clearance on the axle side.

Please note: You will be needing to convert your rear shocks to a through bolt instead of a bar pin at the frame side connection. If going with big boy shocks in the front it will also be through bolt instead of stud top.

Please note: It is recommended that you use an aftermarket sway bar in the rear.

Exhaust notes: Before you start this long arm suspension installation, it is recommended to have your front exhaust modifications completed prior to installation of the system so when your installation is completed you can drive your JK away safely. The recommended exhaust modification is shown in the images below. Please note that the exact procedure may vary depending on the year and engine model of your JK. The goal of the exhaust modification is to make room for the new long arm mounts. It may be helpful to bring the mount and upper control arm to the exhaust shop. Ensure the exhaust is not routed where it can interfere with the hardware going into the long arm mounts.

ROCK KRAWLER

S U S P E N S I O N

SUGGESTED EXHAUST MODIFICATION FOR THE 07- EARLY 10' JK/JKU:

Remove the O2 Sensor and cut the exhaust 4.50" back from the catalytic converter. Relocate the O2 Sensor 2.5" from the end of the first catalytic converter. The O2 sensor will function better when it is hotter. The modification will not hurt its operation.

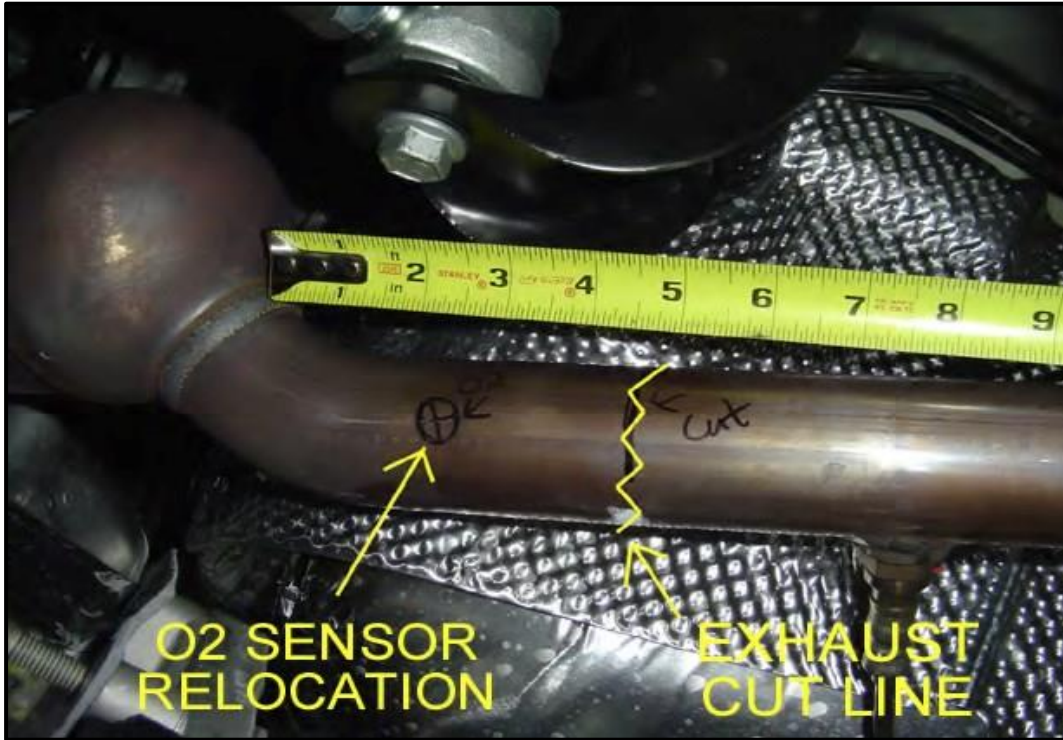

Relocate the resonator after the Catalytic Converter on the driver's side after relocating the O2 sensor. The O2 sensor must be between the cat and resonator. Flip the resonator over 180° and weld it back in place as shown.

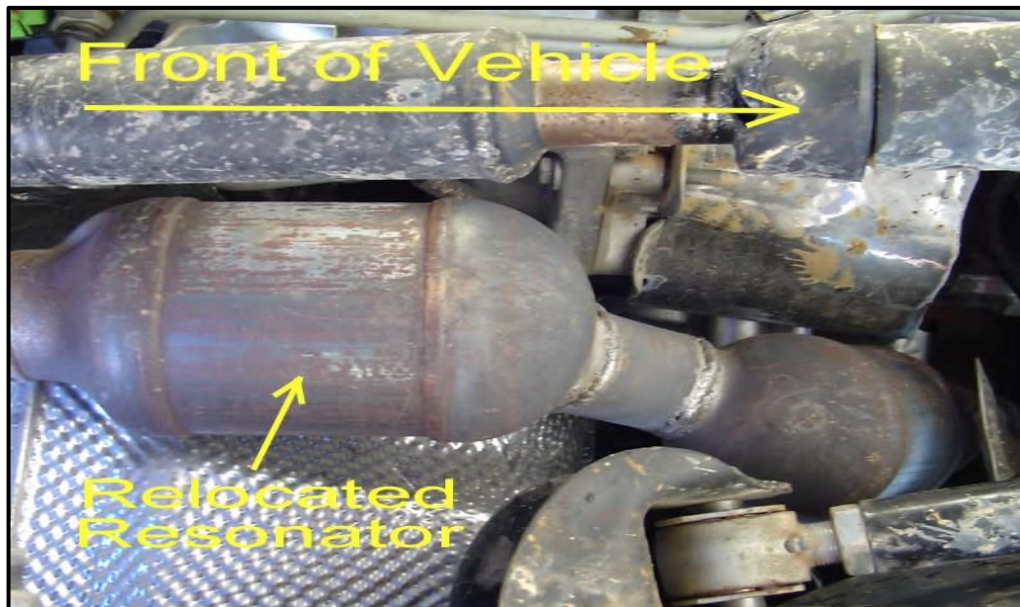

ROCK KRAWLER

S U S P E N S I O N

Modify the cross over pipe and tie the driver's side resonator into the exhaust connection and then bring the entire exhaust system back together. Make sure your modifications allow for clearance for the new mounts and mounting hardware for the arms.

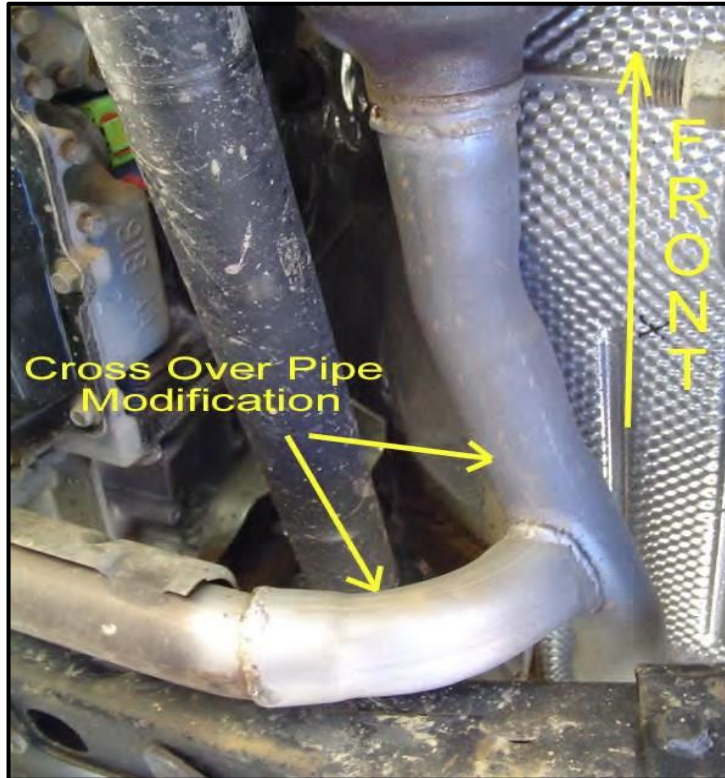

SUGGESTED EXHAUST MODIFICATION FOR THE LATE 10'- 11' JK/JKU

Cut out the catalytic converters - relocate them as close to the exhaust manifolds as possible. Reroute the exhaust around the long arm mounts and tie both left and right pipes back into each other.

SUGGESTED EXHAUST MODIFICATION FOR THE LATE 12'- 18' JK/JKU

You will want to cut out the exhaust loop on the driver's side of the y-pipe. Then reroute the pipe around our control arm mount and tie the crossover pipe back into it. You want to take the movement of the driveshaft during articulation into account as you are rerouting the pipes.



ROCK KRAWLER

S U S P E N S I O N

The Magnaflow loop-delete kit reference number is Part # 19211.



FRONT OF VEHICLE (Perform all Steps for the System you are installing)

- 1) If you are using a floor jack and jack stands, make sure vehicle is on a hard, level, working surface, then, block the rear wheels so the vehicle cannot move and make sure the emergency brake is applied.
- 2) Raise the front of vehicle. Support with safety jack stands. Locate jack stands on the frame in front of the axle. If you are using a vehicle lift, place the lift arms according to those specific vehicles lifting procedures. Ensure that the lift arms will not interfere with the components that are being replaced.
- 3) Remove the front wheels and tires with axle supported by a floor jack.
- 4) Remove the front sway bar links and discard.
- 5) Remove the front shocks and discard. Save the OEM hardware to install the new shocks.
- 6) Do not overextend the front drive shaft. Disconnect the front driveshaft from axle and mark holes to reassemble in the same orientation if needed. Secure out of the way.
- 7) Lower the front axle assembly onto jack stands.
- 8) Remove the front track bar from the vehicle, discard and save the OEM hardware for reuse.
- 9) Remove the front springs and discard, retain the upper isolators for reuse. Neutral upper isolators are required if you are doing Big Boy shocks with coil and shock in front. (RK08244K)
- 10) Remove the front lower control arms and discard, save the hardware for reuse.

ROCK KRAWLER

S U S P E N S I O N

- 11) Remove the front upper control arms and discard arms and hardware.
- 12) Set all the new control arms, sway bar links and track bars to length.
- 13) If doing big boy shocks, you will have to remove the axle shock mount. Refer to coilover tower instructions at the end of this booklet. The shock will also change from stud top to through bolt.
- 14) Clearance the lower control arms with a 1.50" hole saw or grinding wheel. Or go with our heavy-duty weld on front lower control arm mounts. (RK00396) Paint any exposed metal afterwards.



- 15) If you received or purchased the Rock Krawler front stackable bump stops, now is a great time to drill the lower bump stop pad with a 1/2" drill bit. Drill your hole in the center of the pad. We recommend 3 pads for 3.5" of lift and 4 pads for 4.5" of lift. Choose the proper 1/2" bolt.



ROCK KRAWLER

S U S P E N S I O N

- 16) **For the X2 Long arm ONLY. Remove the Passenger Side Front Upper Control Arm axle mount:**
Mark or note the position and orientation of the front upper control arm mount on the passenger side of the axle tube, then remove the OEM mount off the axle. Weld on the new mount as shown, then install the front upper arm as shown in the images below. This mount works up to a 4" tube.

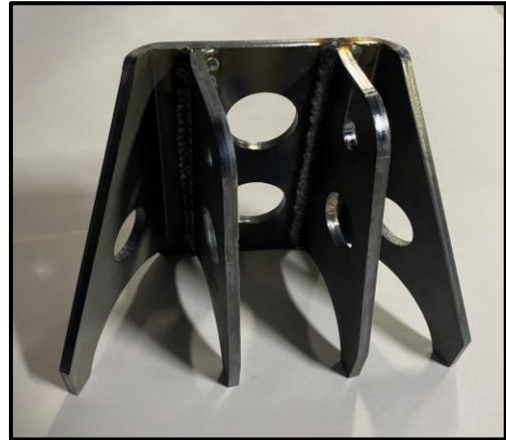

- 17) Remove all of the OEM front upper and lower control arm mounts from the frame. Clean the paint off the inside of the frame where the new long arm bracket touches frame.
- 18) Prepare the frame side front long arm mounts for installation. Pictures on following page.
- Locate the square hole on the inside of the frame ahead of crossmember. Measure 2" up from the top of the square and mark. Measure .81" (13/16th's) back from the back of the square and mark. Mark the intersection of those measurements and use a punch to mark. Drill a small Pilot hole on that intersection. (Picture on following page.)
 - Use a 1.375" hole saw to drill a relief hole for the weld nut in the control arm bracket to sit inside of the frame. (Picture on page 12 of drill in action.)

Please note: If it is an X2 Long Arm this is only needed on the passenger side as the driver bracket does not have an upper control arm.

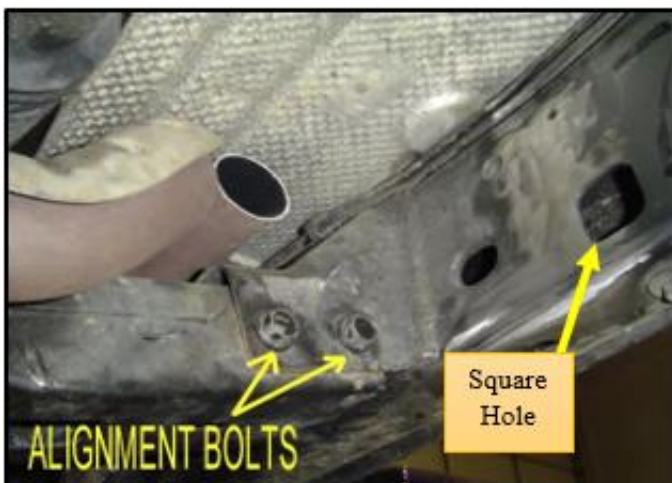

Driver Side

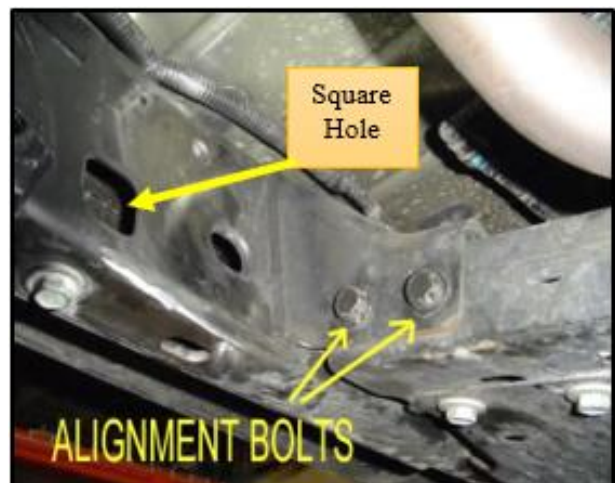

Passenger Side

ROCK KRAWLER

S U S P E N S I O N

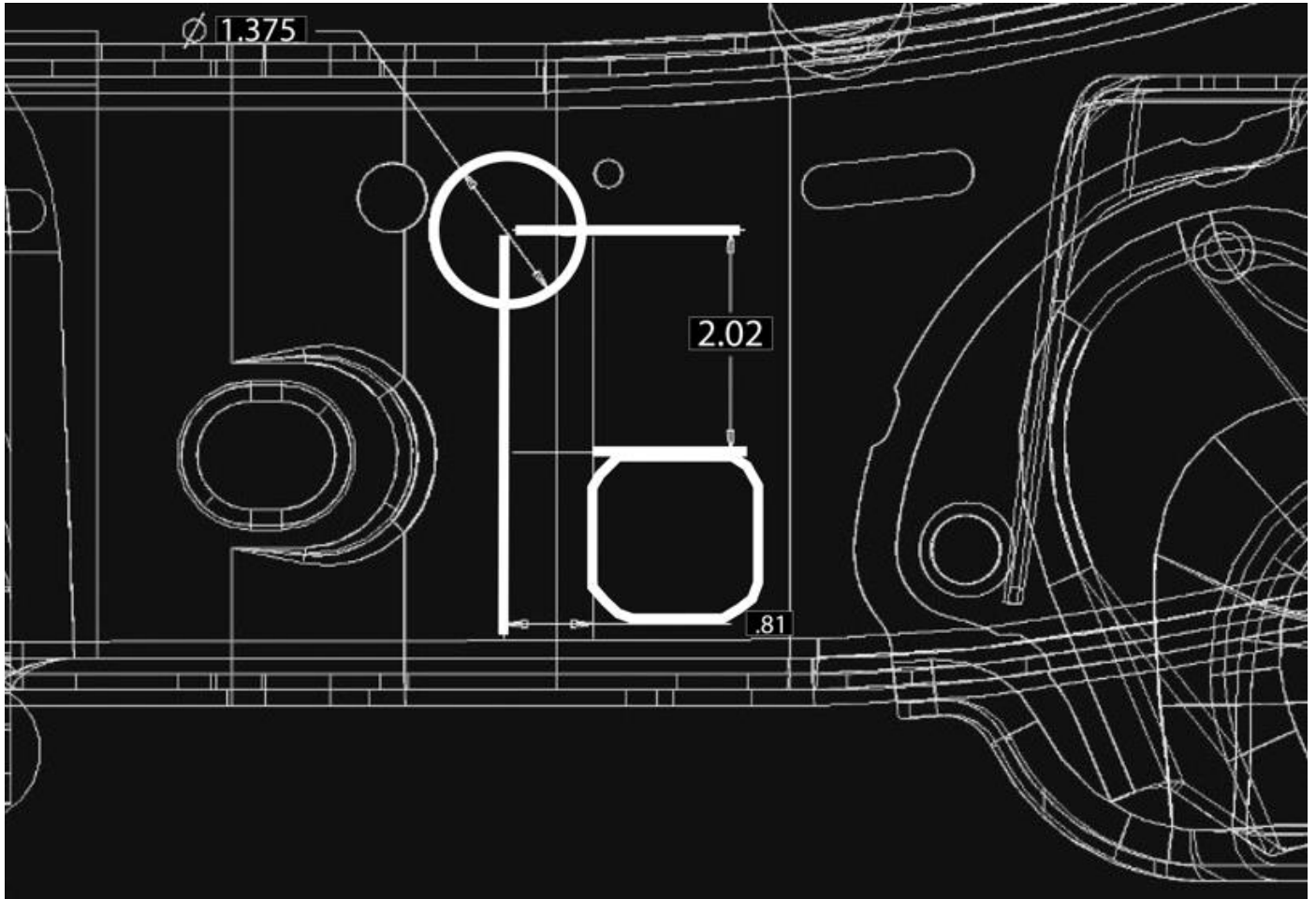

****Not to Scale****

ROCK KRAWLER

S U S P E N S I O N



- c) Use a jack to hold the crossmember before removing the crossmember “alignment” bolts.
- d) Grind away the powder coat from all applicable weld locations on your new long arm brackets. Reference next picture for weld schedule to see where the powder should be removed.
- e) When ready to weld to frame, line up the mount and use an 18mm socket to tighten the mounts. Attach the mounts using the stock bolts, tighten them as you make sure the bracket stays flush to the inside of the frame, and weld it according to the weld schedule shown below. (Schedule is the same even if upper pocket is rotated 90 degrees.) This includes the inside fillet and the bottom side. Then, apply a durable finish of your choice to any exposed part of the frame and bracket. (Installed picture on following page.)

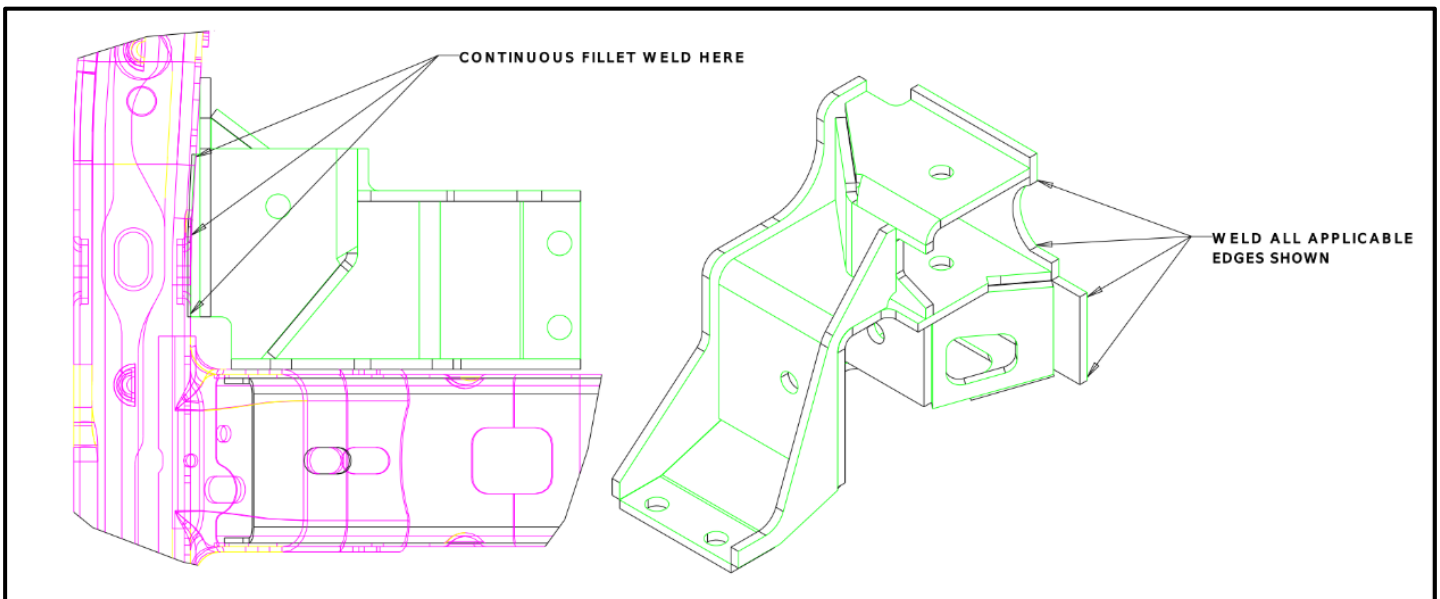

ROCK KRAWLER

S U S P E N S I O N



Adventure Series 2 Mounts shown above (Two front uppers)

- 19) Install both lower control arms with factory hardware into frame bracket.
- 20) Install upper(s) with supplied 14mm into frame bracket.
- 21) Add the included heatshield product to the faces and insides of those mounts. This will keep your joints from prematurely drying out from the exhaust heat. Clean the mount very well first.



- 22) Attach the new cross member tie in plate to new control arm mounts using the (4) supplied 1/2" x 1.25" carriage bolts, 1/2" lock washers, and 1/2" free running nuts.



ROCK KRAWLER

S U S P E N S I O N

- 21) Install the upper control arm(s) on the axle using the stock hardware for Adventure or supplied 14mm x 100mm for X2.

Customers with 4.50" systems prepare for the High Steer Conversion
(Otherwise skip to step 24)

- 22) Install the supplied new high steer track bar mount into the factory track bar mounting location with the supplied 14mm x 80mm bolt and sleeve as well as the supplied 3/8" x 1" hardware with washers and nyloc nuts through the holes in the front of the new relocation bracket that line up with the OEM holes in the factory track bar bracket.

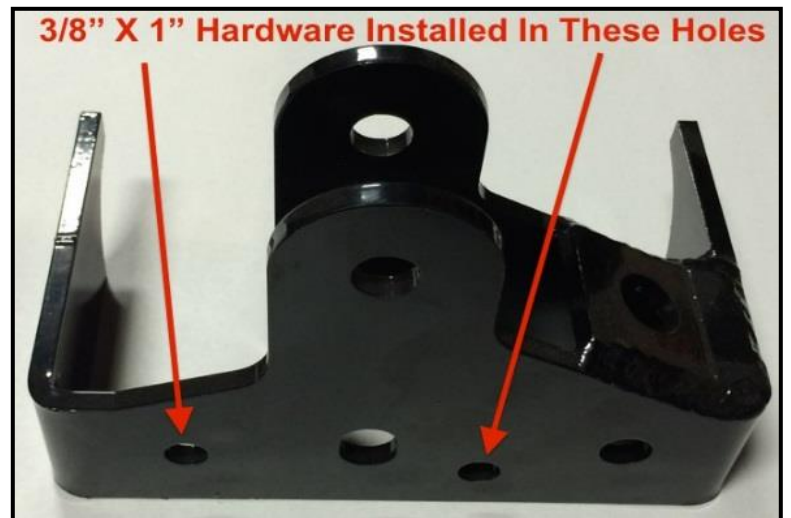
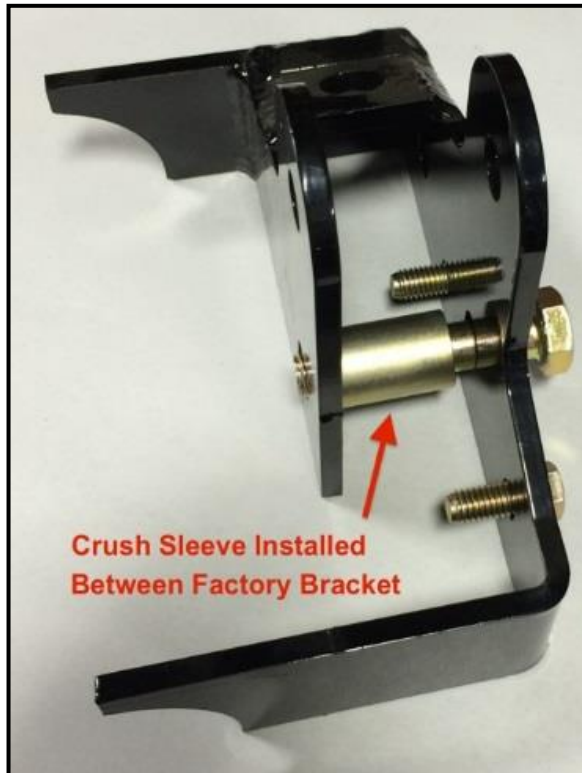

- 23) Mark where the bracket touches the axle tube on both the mount and axle and remove paint to prep to weld. Weld the new bracket to the axle tube using a 1/4" fillet weld around the radii of the bracket that contact the axle tube. Apply a durable finish of your choice to the welds.
- 24) As you are compressing the suspension, install both front coil springs with the stock upper isolators while clocking the spring to sit in the lower spring seat cut out.
- 25) Install the front track bar with the OEM hardware. Be sure to set it to the starting dimensions for your system as specified above. The rebuildable Anti-Wobble Joint (Welded End) goes to the frame connection with the zerk facing down and the anti-wobble (Buna -318) O rings, on each side. The heim joint (non-greaseable joint) with the supplied high misalignment spacers go to the axle connection (or in the relocation bracket). Be sure to have the steering column unlocked so the axle will swing side to side freely.

Customers with 4.50" systems continue with the High Steer Conversion
(Otherwise skip to step 29)

ROCK KRAWLER

S U S P E N S I O N

26) Disconnect and remove the drag link from the vehicle using a pickle fork, ball joint separator or dead blow hammer technique. Record the length of the removed drag link for a starting length for the supplied Pro X Drag link. Discard old Drag link and hardware.

27) Drill out the passenger side knuckle mount position for the new drag link to 7/8" as shown below. A slight ream may be needed but you will want the hardware to be as tightly fitting as possible.



28) Assemble your new Pro X Drag Link. It is straight double adjustable therefore the joints and bar are each directionally threaded so you cannot install the ends backwards. Set your new Pro X Drag Link to the length you noted from the one you removed and install using the supplied hardware. The offset ends goes to the knuckle and the spherical joint goes to pitman arm. **NOTE: There are no grease boots or anti-wobble spacers on Drag link—ONLY the Pro X Tie Rod. Consult Pro X Steering directions on the website for further information.**

29) Center your steering wheel by adjusting the Drag Link. Apply Red loctite to only the threads on the joint near the bar and tighten Jam nuts. Ensure that both joints are in phase with each other (misaligned the same amount in the same direction) before you tighten the jam nuts on the joints.

30) Install the newly supplied Pro Disconnects/Extended Links.



Recommended Starting Lengths 3.5" Systems – 12" / 4.5" Systems 13"

***Please Note:** These are recommended starting lengths. Fully cycle the suspension for clearance/interference checks once your installation is complete to ensure proper operation.

ROCK KRAWLER

S U S P E N S I O N

Top Connection: Working from the inside out, you have the head of the supplied 12mm x 80mm bolt, 12 mm washer, sway bar, shoulder of the billet spacer/sleeve, top joint of the sway bar link, wide washer then the supplied nylok nut as shown above.

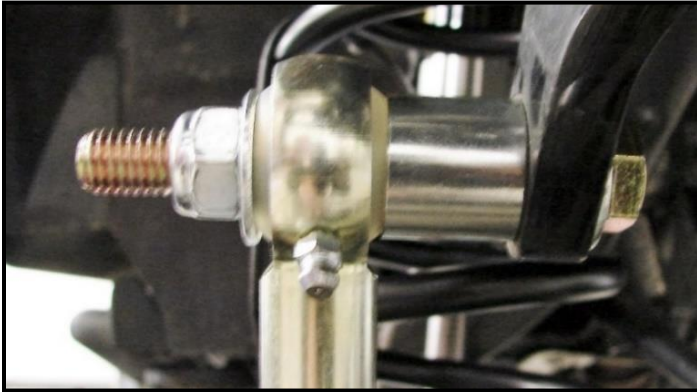

Top Connection



Bottom Connection

Disconnect Connection: Secure the supplied stainless steel disconnect bar pin to the OEM mounting tab with the supplied 1/2" washer under the supplied 1/2" nylok nut. Orient the lynch pin hole in an orientation most convenient for you to get at and make it as easy as possible to remove and disconnect the sway bar.

**Please Note:* There are instances when clearance is tight between the link and the corner of the stock spring mounting pad. It may be required for you to add clearance to the corner of the spring pad as shown below. Use your discretion to ensure this is done if required.

To Install your sway bar link straps:

Drill a 5/16" hole in the coil bucket as shown in the picture below and secure the fixed end of the sway bar link strap with the supplied 5/16" x 1" bolt, washers and nylok nut as shown below to the right.



**Please note:* When disconnecting, wrap the sway bar link strap around the sway bar and link. Then secure them up and out of the way. When not using the sway bar straps it is recommended the bottom end of the straps be removed and stored in a safe storage place.



27) Remove the factory front rubber brake lines and install the supplied extended stainless-steel brake lines (Part Number RK02038). Be sure to add slack to your axle breather tube, ABS lines and route them with your new stainless-steel lines. Use the supplied zip ties to secure them to each other.

**Please Note:* The factory front brake lines on a 07'-10' are routed differently than the front brake lines on a 11'+. We use the same brake line for all of our JK products thus we require you to route the line on the 11'+ just as if you were routing a line on the prior year JK's. The 15-degree angle built in the fitting is designed so the line is pushed away from the tire and wheel assembly.

28) Install wheels and tires and lower vehicle to the ground. Tighten any remaining connections required.

REAR OF VEHICLE (Perform all Steps for the System You Are Installing)

- 1) Make sure the vehicle is on a level, hardworking surface if you are using a floor jack and jack stands.
- 2) Block the front wheels so the vehicle cannot move.
- 3) Raise the rear of vehicle and support with safety jack stands. Locate jack stands on the frame behind the rear axle.
- 4) If you are using a vehicle lift, place the lift arms according to those specific vehicles lifting procedures. Ensure that the lift arms will not interfere with the components that are being replaced.
- 5) Remove the rear wheels and tires with axle supported by a floor jack.
- 6) Remove the rear shocks and discard.
- 7) Remove the rear sway bar links and discard.
- 8) Remove the wire hanger for the rear emergency brake cable and route them to have as much slack as possible.
- 9) Do not overextend the drive shaft. Disconnect the rear driveshaft from axle and mark holes to reassemble in the same orientation if needed. Secure out of the way.
- 10) Lower the rear axle assembly onto jack stands.
- 11) Remove the rear coil springs and discard. Save OEM upper isolators for reuse.
- 12) Remove the rear track bar and discard, save the OEM hardware for reuse.
- 13) Remove the rear lower control arms, save the OEM hardware for reuse.
- 14) Remove the factory rear upper control arms. Discard the arms and hardware.
- 15) Remove the rear sway bar assembly from frame. Discard if using an aftermarket one.
- 16) Remove all of the OEM rear upper and lower control arm mounts from the frame.
- 17) Remove the rear shock mounts on the frame/ crossmember. Pictures to follow.
- 18) Remove all of the OEM rear axle control arm mounts and shock mounts.

ROCK KRAWLER

S U S P E N S I O N

19) Install the rear upper control arm mount onto the frame. The bracket spans the two rear frame cross members and aligns off the holes in each cross member as shown below. Check fitment and remove any paint where the bracket touches the crossmembers. Clamp the bracket with the holes aligned to the cross members and weld it in place using a 1/4" fillet weld as shown below. Apply a durable finish of your choice after welding.

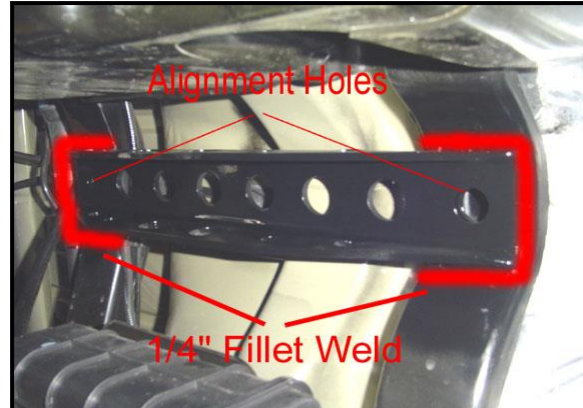
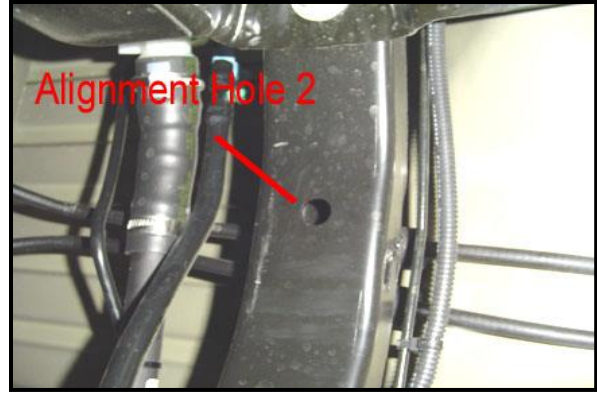
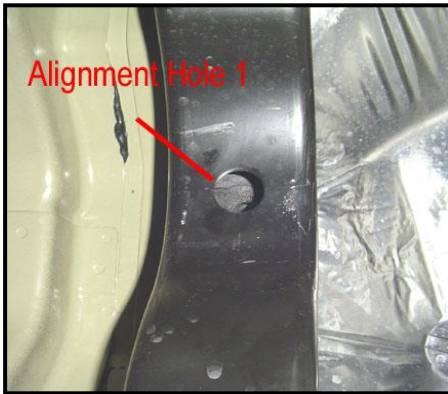

20) Install the cradle onto the rear axle. Center the cradle left to right on the axle and make sure the third link mount on the top is open to the front. Then hold the offset tool as shown below against the factory differential cover and rotate the cradle back until it contacts the offset tool. Remove any paint where the cradle touches the axle for a good weld. Weld it in place on front and back using a 1/4" fillet weld as shown below. Apply a durable finish of your choice after welding.

***Please Note:** Our rear cradle and axle brackets are designed around OEM axles. If you have another axle contact us for proper brackets.

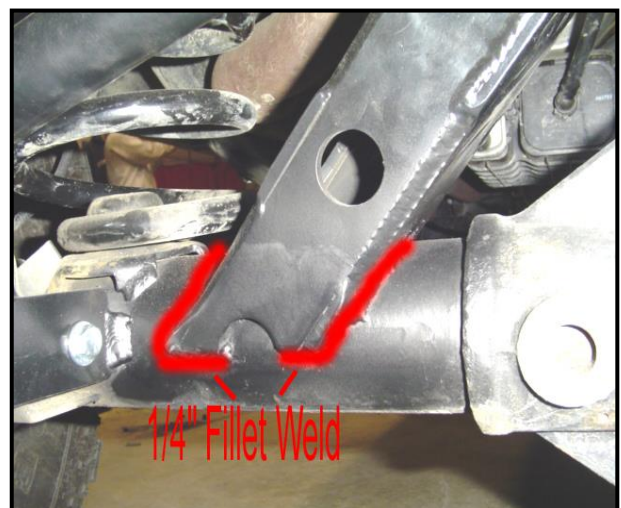
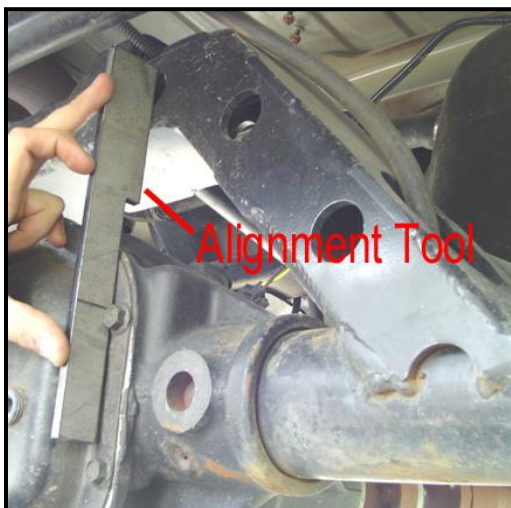

ROCK KRAWLER

S U S P E N S I O N

21) Clearance the rearward most body mount on the outside of the frame for the new long arm during up travel. You might elect to shave the body mount down and use a shorter bolt if your shock set up allows contact with the arm. Remove up to the metal sleeve leaving final surface flat for washer to contact.



22) Prepare to install the supplied rear long arm mounts on the frame.

- a) The mounts are located off the oblong hole in the side of the frame. Reference the 1.45" and 2.83" dimensions from the oblong hole in the frame. Drill with a 1.50" hole saw to make clearance for the weld nut so the mount can sit flush on the frame.
- b) The mounts are located off the oblong hole in the side of the frame as shown page. Weld them in place using a 1/4" fillet weld.

Please Note: Keep the top edge of the mount horizontal when welding in place. There is a specific driver side and passenger side, the open end of the mount faces rearward as shown below. Shown below is the passenger's side.

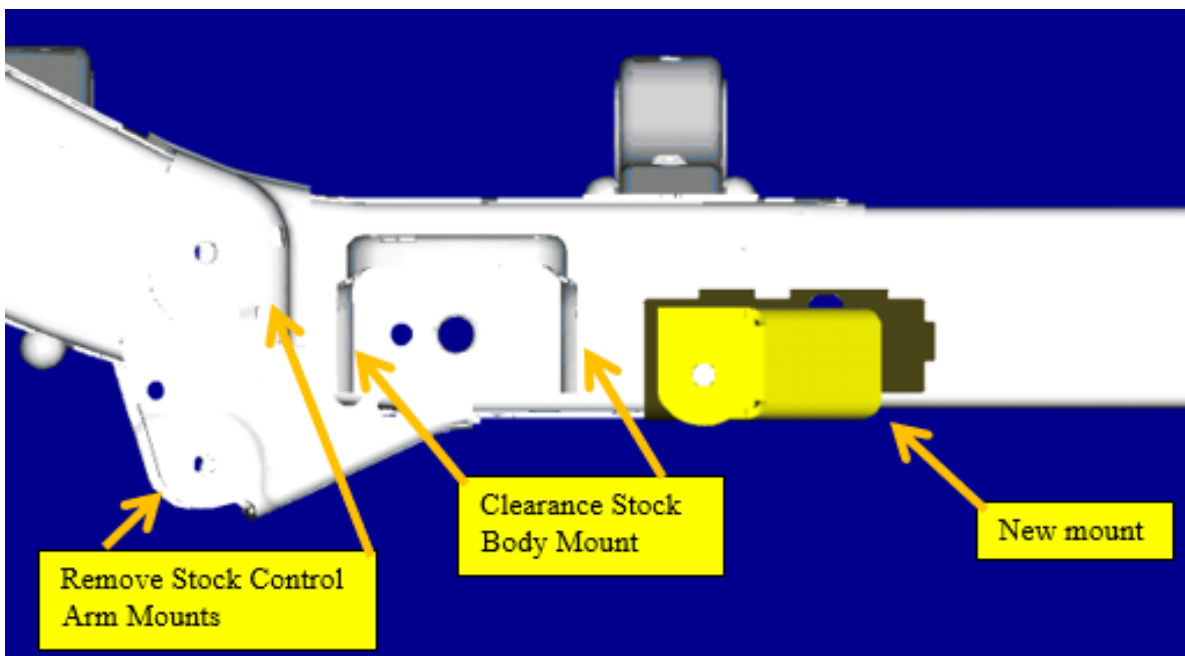

ROCK KRAWLER

S U S P E N S I O N

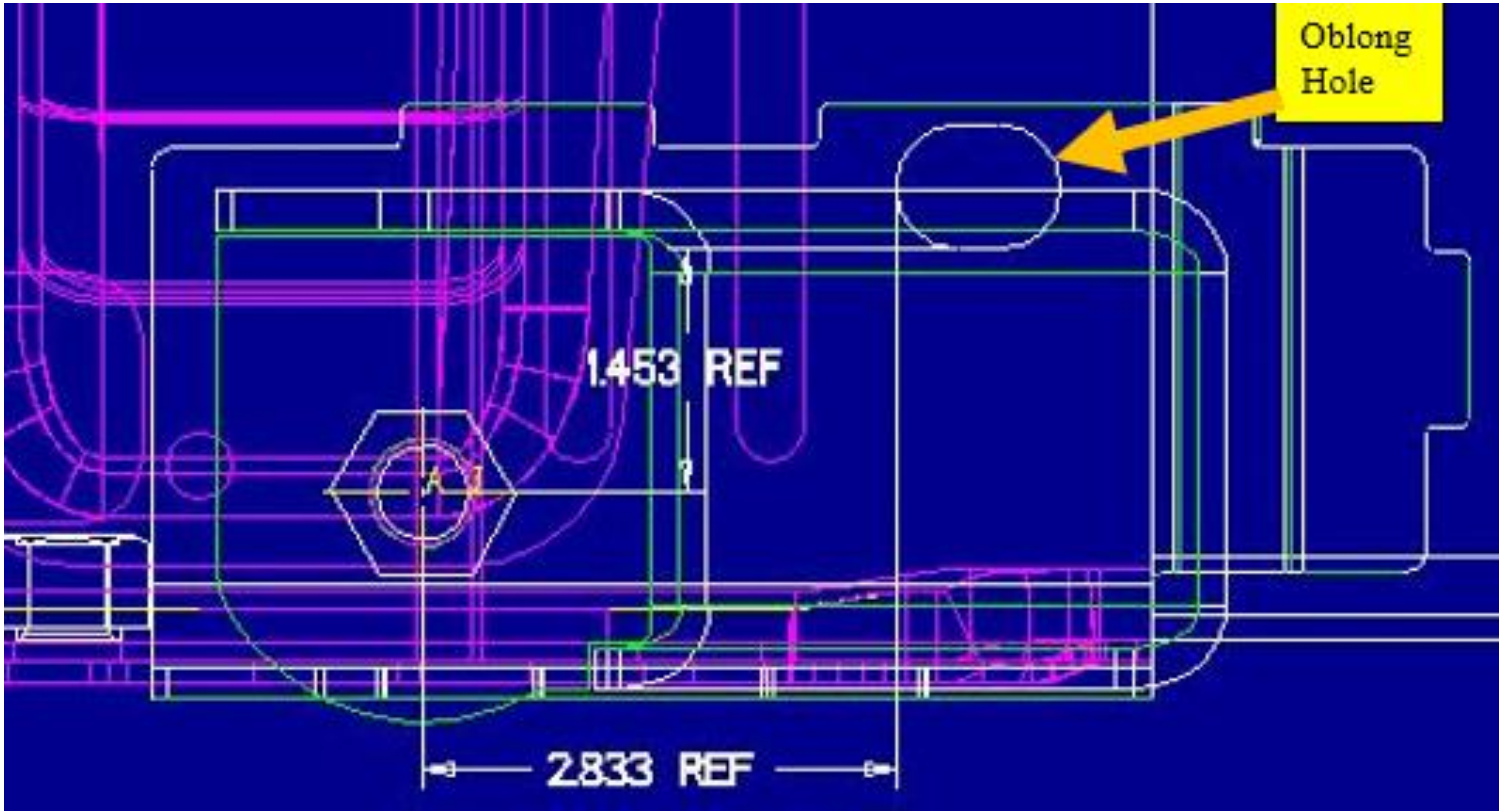

ROCK KRAWLER

S U S P E N S I O N

23) Prepare to install the rear frame side X2 shock brackets. Pictures on following page. **Note: the upper mount on the shock brackets will now be through bolt instead of bar pin.**

- a) If the stock brackets have not been removed, remove them at this time.
- b) Grind the inside of the frame surface flat.
- c) The crossmember is double layered and a notch will need to be cut for the leg of the new mount.
- d) Clearance/ remove any muffler hangers in the way.
- e) Continue to test fit brackets until they sit flush. Prepare the brackets by removing any powder coat that touches the frame. Some Jeeps might require messaging the tub to fit the bracket.
- f) Weld in the brackets using the locator leg that wraps under the frame to position. Once you tack in the bracket you can bend the other leg where needed to contact the crossmember or cut it off.
- g) Allow it to cool and apply a durable finish.



ROCK KRAWLER

S U S P E N S I O N

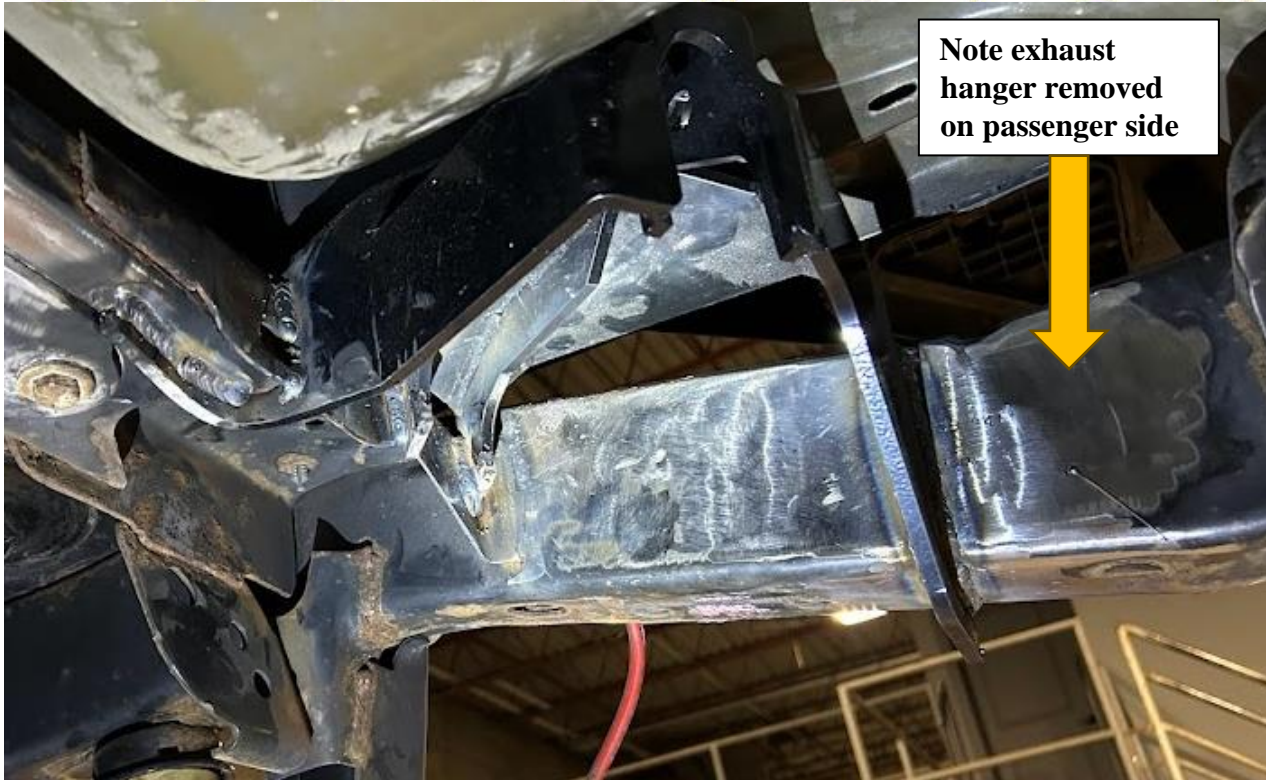

****Regular brackets shown, 6" stretch will be much larger and further back from crossmember****

ROCK KRAWLER

S U S P E N S I O N

24) Now that you are done with the frame side prepare to install the axle control arm brackets. They called the X2 rear axle brackets and raise up the shock and control arm for greater ground clearance.

- a) Use the supplied bracket locator tab and 3/8" hardware to orient the new bracket off the axle bump stop pad. The locator bracket bolts to the stock bump stop location in the front hole of the pad. The bracket bends down toward the wheel. The bracket then bolts to the control arm portion to hold it to axle.
- b) The shock mount portion of the mount goes to the rear and "points" inward, away from tire.
- c) Clean any paint on both the bracket and axle where the bracket touches for a good weld.
- d) Weld the bracket in after confirming final fitment. Large axle tube diameters require a larger mount. Contact us for assistance. 518-270-9822
- e) Let the welds cool and paint any exposed metal with a durable finish of your choice.



ROCK KRAWLER

S U S P E N S I O N

Steps 25, 26 and 27 For 2 Door 6" Stretch systems Only (Otherwise skip to step 28)

25) **On 2 Door 6" Stretch Only: Prepare to install the axle coil buckets.**

- a) Mark the position and orientation of the OEM spring pads on the axle and remove.
- b) Position the new mounts in the stock location you marked. Remove any paint on the mount or axle where they touch for a good weld.
- c) Orient the spring pad to your lift height spec.
 - i) **For 3.5" lift height:** 5 to 7 degrees down from the factory pad orientation.
 - ii) **For 4.5" lift height:** 7 to 9 degrees down from the factory pad orientation



Stock



6" Stretch

Please Note: These orientation corrections should correct for pinion rotation. The spring pads should be horizontal at ride height on a level surface. Once proper pinion angle and spring pad positioning is verified, fully weld in using a 1/4" fillet weld. Then apply a durable finish of your choice.

26) **On 2 Door Stretch Systems only:** Depending on axle and truss configuration you may have to cut a clearance pocket in the rear most cross member as shown below. It is recommended that you box it back in as well as shown.

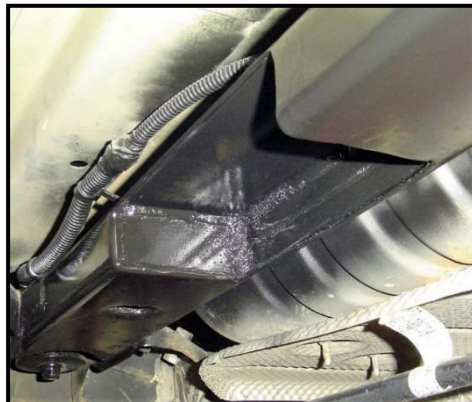

ROCK KRAWLER

S U S P E N S I O N

- 27) **On 2 Door 6" Stretch Only: Prepare to install the Frame sidetrack bar bracket:** Install the new frame mounted track bar bracket as shown below. The 6" stretch mount should be mount 6" back. Be sure the trim the new mount so it is square and fully welded in place. Once completed you can completely remove the OEM mount from the frame.

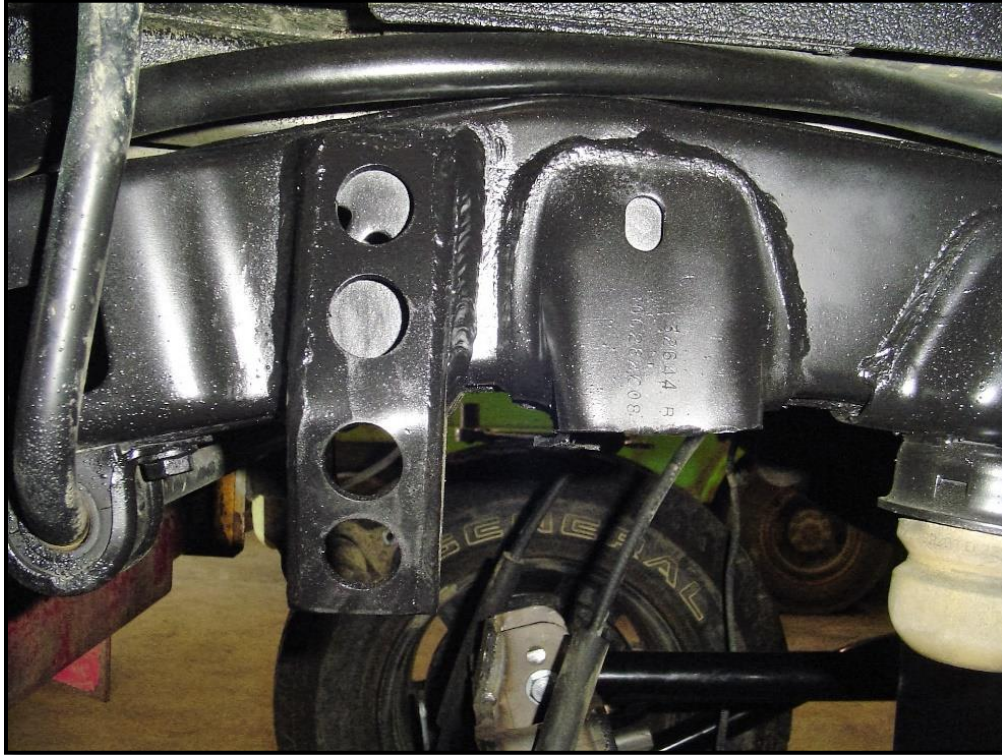

On 2 Door Stretch Only: The OEM Bump Stop Cup on the frame side must be moved back accordingly as well to match up with the axle bump stop pads.

- 28) Mark the position and orientation of the OEM rear track bar bracket on the axle as shown on the left below. This is extremely important; you want to get the mounting points as close to identical as possible. You will be removing the problematic rear track bar bracket and replacing it with the newly supplied heavy duty one as shown below. Tack In the new track bar bracket at the same angle as your differential cover. It is highly suggested that you install your rear shock to check for clearance before completely welding the bracket. Shown below is one of our RRD 2.625" remote reservoir shocks.

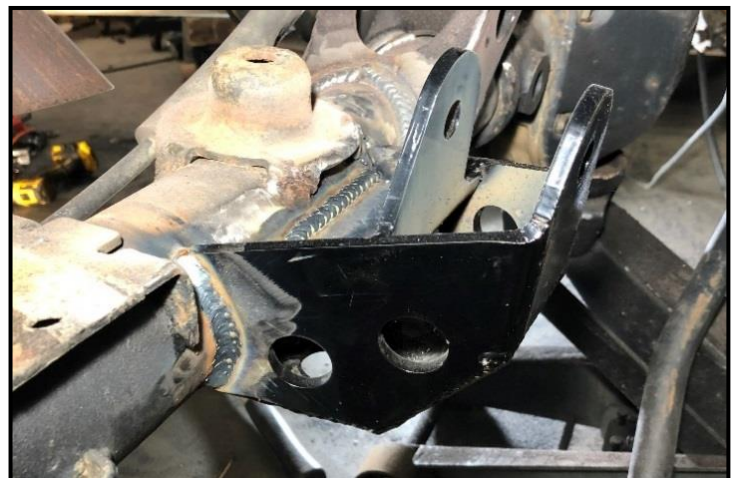

ROCK KRAWLER

S U S P E N S I O N



29) Set your lower control arms to length and install them using the supplied 14mm x 100mm. For Adventure X the Jam nut will go up to the frame side to protect it from rocks and for ease of reaching. For the X2 the Jam nut and Krawler joint will go to Axle to get the most misalignment out of the arm. The Krawler joint Zerk fitting should face up to protect it from rocks. The bend in both arms goes up for ground clearance.



30) Set the rear upper to length balancing the threads on each joint and install using supplied 14mm x 90mm hardware. Ensure the bend is oriented downwards for up travel. On X2 make sure the Anti-wobble bushings are on either side of the frame joint to prevent rotation side to side.

31) Set your rear trackbar to length and install. Ensure the heim end goes to the axle side connection, and the bends are oriented away from the differential cover. Do not lose the two rubber O-rings (anti-wobble isolators) at the frame end. Grease the inside of the frame side bracket so the rings do not rip. the front track bar with the OEM hardware. Be sure to set it to the starting dimensions for your system as specified above. The rebuildable Anti-Wobble Joint (Welded End) goes to the frame connection with the zerk facing down and the anti-wobble (Buna -318) O rings, on each side. The heim joint (non-greaseable joint) with the supplied high misalignment spacers go to the axle connection (or in the relocation bracket).

ROCK KRAWLER

S U S P E N S I O N

31) Install the spring correction degree shims under the rear coils on the axle. Reuse the OEM upper isolators. The thick parts of the axle shim are oriented towards the rear of the vehicle.



32) Install the Rock Krawler rear coil springs. Make sure to put the end of the coil winding all the way to the rear of the lower coil pad.

Helpful Hint: A simple and cost-effective way to retain the rear coils to the axle is to use a hose clamp up through the center hole of the spring pad and clamp it around the bottom winding of the coil spring

33) Install the sway bar system of your choice at this time and connect the sway bar links to your new lower control arm brackets. We recommend you go with an aftermarket set up. If you are reusing the stock sway bar relocate it behind the new shock bracket while still being as far forward as you can. To do so, mark then drill 4 new holes with a 5/16" drill bit. Then install the stock bar using the (4) supplied 3/8 thread forming screws.



ROCK KRAWLER

S U S P E N S I O N

34) Install the rear shocks using the OEM hardware and supplied spacers. Put a spacer on the inside of the shock bracket on the side closest to the track bar top and bottom to push the shock away from track bar bracket.



35) Install bump stops if purchased additionally. If you purchased a kit with shocks they will be supplied.

Please Note: Our rear fabricated bump stops mount to the factory bump stop pad on the rear axle using the supplied hardware. Use the existing holes in the factory pads. Make sure the bumps stop angles to the front of the vehicle as shown in the photo below. Use 1 puck for a 3.50" lift and 2 pucks for a 4.50" lift.

On 2 Door Stretch Only, The OEM Bump Stop Cup on the frame side must be moved back accordingly as well to match up with the axle bump stop pads.



ROCK KRAWLER

S U S P E N S I O N

- 36) Remove the factory rubber brake lines and install the supplied extended stainless-steel brake lines. Be sure to add slack to the ABS line, then secure the ABS and stainless-steel brake lines together with zip ties and route them carefully. Now you can go ahead and bleed the brake system per the JK service manual.
- 37) Install the rear wheels and tires and lower the vehicle to the ground.
- 38) Tighten all mounting bolts at this time!

Congratulations, you have just finished installing your Rock Krawler Suspension System! Your Jeep is now free to roam about the country.

Before hitting the pavement or the trails be sure to make sure the control arms are oriented properly, all spherical joints (heim joints and Krawler Joints) are oriented correctly to allow for maximum movement without bind, and all jam nuts have Loctite on them and are tight. Make sure the axles are properly centered, pinion angles are correct, there is proper slack in ABS lines, and all lines are properly routed. Go back over all your hardware and make sure each connection is tightened to its proper torque spec. Check your vehicles articulation and ensure that no moving parts contact or interfere with any other components throughout the travel (brake lines, shocks, coils, sway bar links). Also check to see if at full flex your coil spring loses tension, if so you may want to look into a limit straps. You may need to look at bump stops depending on what shocks you choose to run.

ROCK KRAWLER

S U S P E N S I O N

Recommended Alignment Specs are as follows:

2.5" Lift Height: 4.5 to 6.0 degrees of Caster with a .2 to .4 Cross Caster Split (.2 to .4 degrees more caster on the pass. side than the driver's side.)

3.5" Lift Height: 4.2 to 5.5 degrees of Caster with a .2 to .4 Cross Caster Split (.2 to .4 degrees more caster on the pass. side than the driver's side.)

4.5"/5.5" Lift Height: Minimum of 4.0 degrees of Caster with a .2 to .4 Cross Caster Split (.2 to .4 degrees more caster on the pass. side than the driver's side.)

Tow: 0 to slightly towed in but within factory specifications

The rear pinion angle should be down 2 – 3 degrees from the driveshaft as shown below.

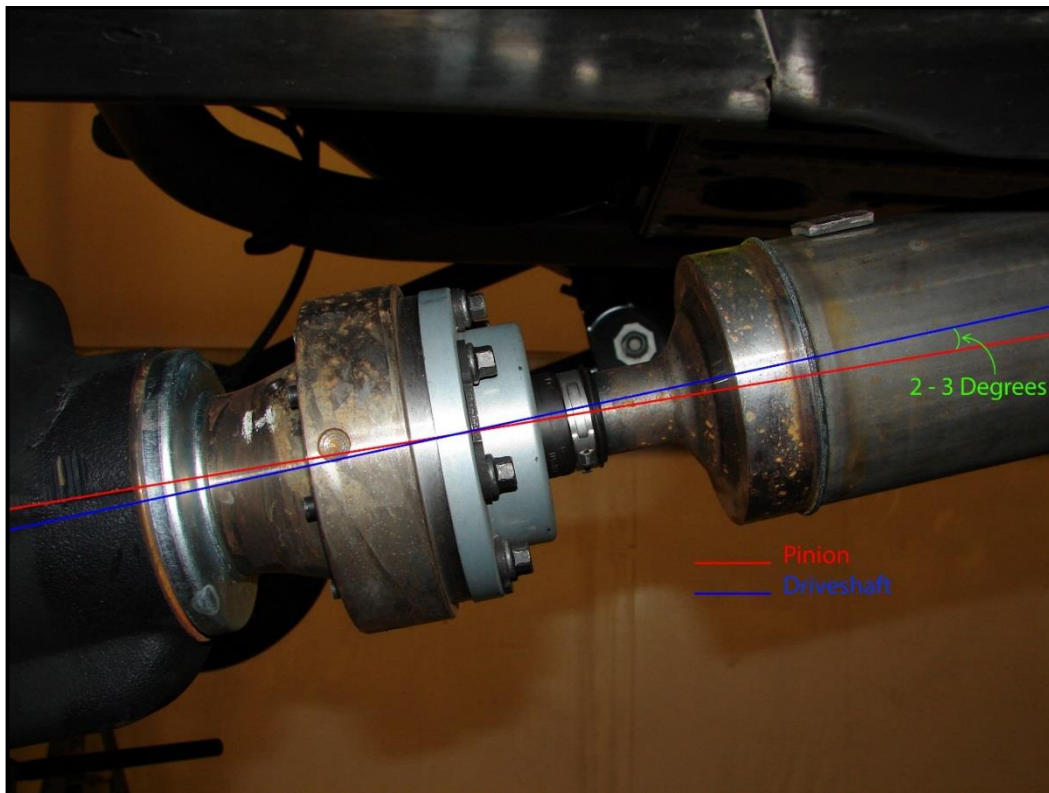



Common Service Parts Listings:

Rock Krawler 000 Grade Grease – 3 oz tube – RK05494 For Systems Before Jan 1, 2020

Grade 1 Grease such as Mobil Grease – Mobilux EP1 [NLGI 1] or equivalent can be used for Systems After Jan 1, 2020.

Front and Rear Lower Control Arms Prior to 3/1/2021

Please contact the office for proper service parts. There were two product updates over the 14-year run.

Front and Rear Lower Control Arms After to 3/1/2021 Part Numbers

Adventure Joint on both systems (Frame End) – RK07403K

Adventure X2 Full Replacement Joint (Axle End) – RK08192

Adventure X2 Bushing Replacement (Axle End) – RK07403K

X2 Full Replacement Krawler Joint (Axle End) – RK04821

Krawler Joint Rebuild Bushings – RK04034K – Requires Large Joint Tool – RK04484

Front and Rear Track Bars Prior to 1/1/2021

Please contact the office for proper service parts. There were two product updates over the 14-year run.

Front and Rear Track Bars After to 1/1/2021 (RK02024HD and RK02026B)

Anti-Wobble Joint Bushings (Frame End) – RK07836K – Requires Small Joint Tool – RK04487

Front Track Bar Replacement Heim Joint (Axle End) – RK07535 (1” Shank) – Optional New Misalignment Spacers – RK03428

Rear Track Bar Replacement Heim Joint (Axle End) – RK03426 (7/8” Shank) – Optional New Misalignment Spacers – RK03428

Front Upper Control Arms:

*****Adventure: Axle side bushings in the axle housings are OEM and we do not sell them*****

Adventure X2 Full Replacement Joint- RK07427

Adventure X2 Bushing Replacement – RK07417K

X2 Full Replacement Krawler Joint (Frame End)– RK04153

Krawler Joint Bushings – RK04034K – Requires Large Joint Tool – RK04484

Rear Upper Control Arms:

Adventure X2 Full Replacement Joint- RK07427

Adventure X2 Bushing Replacement- RK07417K

X2 Full Replacement Joint– RK04153

Krawler Joint Bushing – RK04034K – Requires Large Joint Tool – RK04484

Sway Bar End Links:

Ball Center – RK04573

ROCK KRAWLER

S U S P E N S I O N

Front Coil over tower Installation

Please Note: This must be done with the coil spring removed.

- 1) Remove inner fenders on each side. Also remove the battery.
- 2) Remove the stock spring towers. They can be removed easily with three cuts and a crescent wrench.



HELPFUL HINT: Be careful of the breather hose, brake lines, and ABS wires while cutting. Disconnect the ABS line and route it under the frame (temporarily) if necessary.

- 3) Once both mounts have been removed, use a flap disk to clean off the weld scarring. Then apply a durable finish of your choice.



ROCK KRAWLER

S U S P E N S I O N

- 4) Prepare to clearance for the top of the tower to fit in wheel well.
 - a) Once the battery has been removed you can start to clearance the battery box to fit the tower as shown below. Cut off wheel, Tin snips and end nippers seem to work the best. Keep test fitting until it lines up with frame locator hole and sits on top of coil bucket.
 - b) On the driver's side nothing needs to be uninstalled to clearance for tower. End nippers will get to about everything you need to remove.

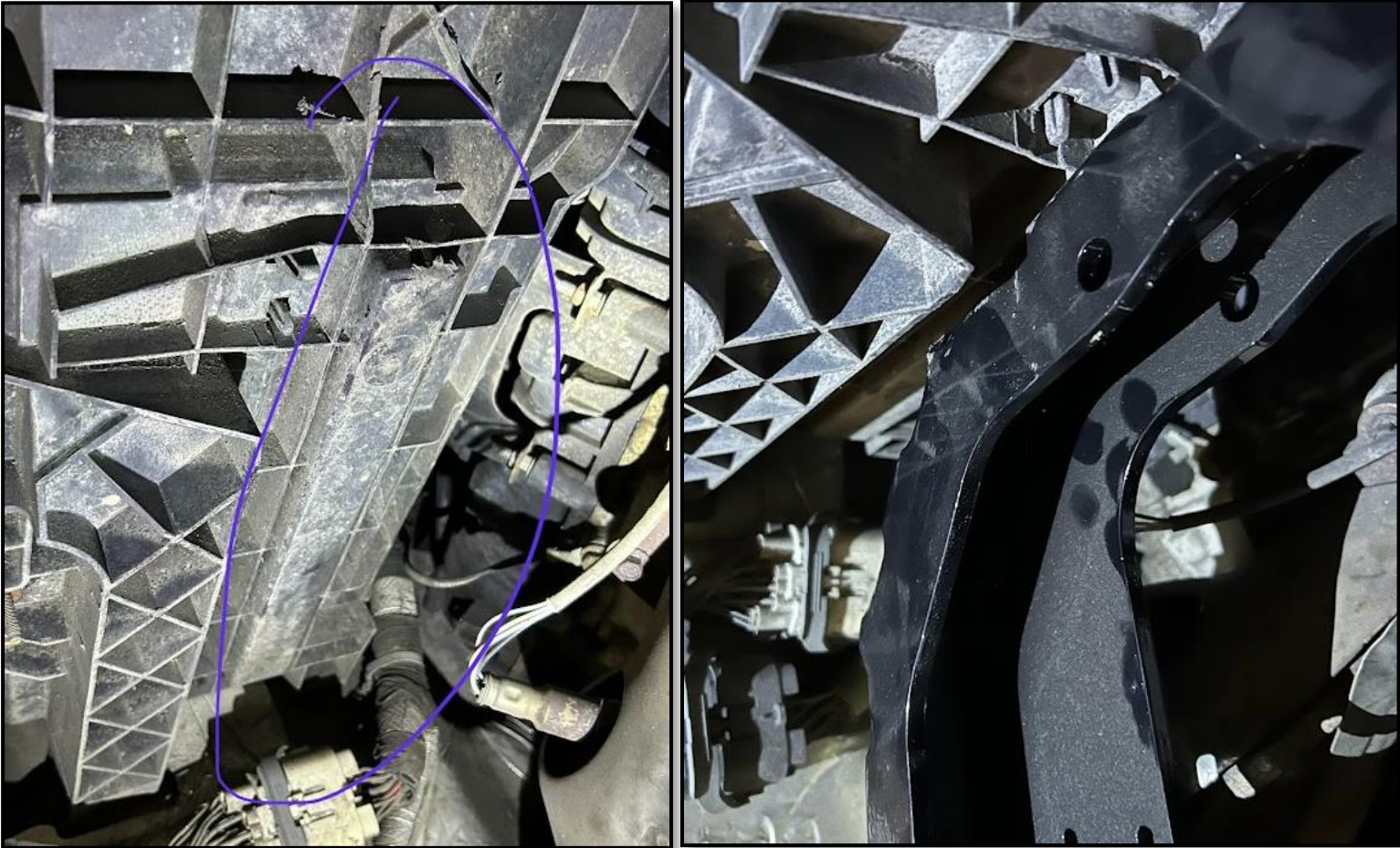

- 5) Place your new coilover mounts on the frame. Center the top of the bracket on the coil bucket and center the lower cutout around the oblong frame hole as shown below.



ROCK KRAWLER

S U S P E N S I O N

- 6) Clamp everything down with C-clamps. Drill one 1/2" hole for the frame connection about the oblong hole. Bolt it down with the provided 1/2" x 1.25" bolt, two washers and a locknut. and center the top connection about the spring tower. Clamp it while it is centered, and carefully drill three 7/16" holes for the coil bucket connection. The driver side will require you to move the windshield washer bottle out of the way. Bolt the three spring mount connections using 7/16" x 1.5 UNC bolts, two washers and a locknut per connection. Insert the bolts from the bottom up. Then add the second frame side 1/2" x 1.25" bolt, washers, and locknut.



- 7) Next, remove the OEM axle side shock brackets from the axle. You may need to use a Dremel tool to get the last of the bracket off from inside the spring perch.
- 8) Place a digital angle finder on the front axle upper ball joint. Set that axle to zero. Then place the lower mounts 1/2" from the inner "C." Then make sure the top surface reads zero degrees at ride height before welding the mount into place.

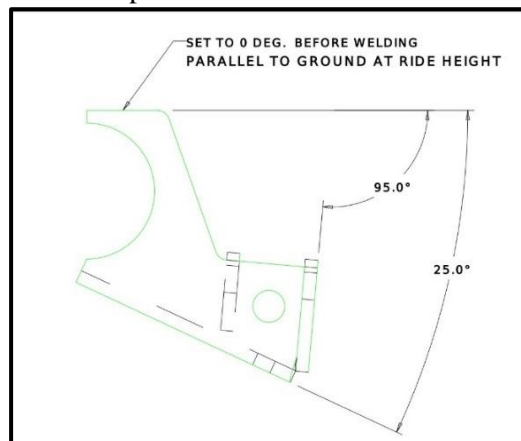

ROCK KRAWLER

S U S P E N S I O N

- 9) Paint the lower coil over mount with a durable finish of your choice.
- 10) Insert the coil overs for test fitment on the lower mount. If you have a stock axle, then make sure there is no clearance / interference with the OEM Brake line bracket on the bottom of the coil over mount.



- 11) Install coil over with minimal preload and transition rings in a spot where the slider will not contact. Place the supplied spacer on the top coil over connection on the inside against the bearing and bracket. Then secure the top connection with a $\frac{1}{2}$ " x 3.25" bolt with a washer on each side and locknut on the backside. Then place the $\frac{1}{2}$ " x 2.75" bolt through the bottom connection with a washer on each side, locknut on the back. ***Please Note:** These mounts are designed as large shock mounts as well as coilover mounts. The spacer simply makes this coilover compatible. Remote Reservoirs should orient them as shown.
- 12) Adjust coil overs after a 50-mile mild break in period.
- Unload the vehicle weight from shock
 - Bring down Preload adjuster to desired ride height. Approximately 3" from the bottom of the top cap to the top of the ring for 4.5" of lift.
 - Drive another 50 miles
 - Using a screwdriver or tool of your choice adjust the transition rings to 1" above the black nylon slider.
 - Drive another 50 miles.
 - Make final adjustments based on driver preferences. Moving the transition rings closer to the nylon slider will make the coil over get into the stiffer rate quicker and more often.
- 13) Tighten everything to spec and reinstall all components removed to do the install.